

Liberty® Cyclor User's Guide

© Copyright 2011 – 2015, Fresenius Medical Care—All Rights Reserved

This document contains proprietary information of Fresenius USA, Inc. d/b/a Fresenius Medical Care North America and its affiliates (“Fresenius Medical Care”). The contents of this document may not be disclosed to third parties, copied, or duplicated in any form, in whole or in part, without the prior written permission of Fresenius Medical Care.

Fresenius Medical Care, the triangle logo, stay•safe, and Liberty are trademarks of Fresenius Medical Care Holdings, Inc., and/or its affiliated companies. All other trademarks are the property of their respective owners.

US Federal law restricts this device to sale only by or on the order of a physician. Frequency, duration, and parameters of treatment are to be determined by the prescribing physician.

Indications for Use: The Liberty cyclor is intended for acute and chronic peritoneal dialysis.

This document is for software version 2.8 and higher.

My Treatment Parameters

Use this page for your treatment values as prescribed by your doctor. Use only one of these prescription cards for your treatment.

therapy	CCPD	<input checked="" type="checkbox"/> Treatment Based
cycles/pauses	volumes	times
	total volume	total sleep time
	fill volume	
	last fill volume	

therapy	CCPD	<input checked="" type="checkbox"/> Cycle Based
cycles/pauses	volumes	times
# fills	fill volume	dwelt time
		fill time
	last fill volume	drain time

therapy	IPD	<input checked="" type="checkbox"/> Treatment Based
cycles/pauses	volumes	times
	total volume	total sleep time
	fill volume	
# pauses	pause volume	

therapy	IPD	<input checked="" type="checkbox"/> Cycle Based
cycles/pauses	volumes	times
# fills	fill volume	dwel time
# pauses	pause volume	fill time
		drain time

therapy	PD+	<input checked="" type="checkbox"/> Treatment Based
cycles/pauses	volumes	times
	total volume	total sleep time
	fill volume	
# pauses	pause volume	
	last fill volume	

therapy	PD+	<input checked="" type="checkbox"/> Cycle Based
cycles/pauses	volumes	times
# fills	fill volume	dwel time
# pauses	pause volume	fill time
	last fill volume	drain time

therapy		TIDAL		<input checked="" type="checkbox"/> Treatment Based
cycles/pauses		volumes		times
	total volume		total sleep time	
# pauses	pause volume			
	first fill volume			
	tidal fill volume			
	tidal drain vol.			
	last fill volume			

therapy		TIDAL		<input checked="" type="checkbox"/> Cycle Based
cycles/pauses		volumes		times
# pauses	pause volume		dwell time	
	first fill volume		fill time	
# fills	tidal fill volume		drain time	
	tidal drain vol.			
	last fill volume			

patient

your ID	weight

options

add diurnal UF	last bag option	
language	SI units	personal data
USB enabled		

Notes: _____

Contents Quick Search

This page is a quick reminder where to find certain procedures:

Emergencies

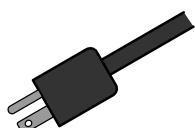

Power Failure: 196

Troubleshooting Error Messages: 180

Liberty Cyclor Settings



How to set weight (SI) units: 80

How to change the time/date: 82

How to set screen blanking: 82

How to adjust the alarm/key volume: 82

Treatment Setup

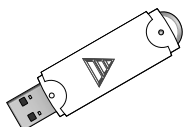

How to use the IQdrive: 162

How to set your parameters: 46

Pre-Treatment checklist: 86

Exchanges

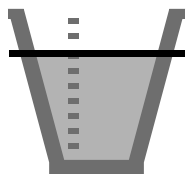

How to bypass: 158

How to do a STAT drain: 156

Drain times based on Fill volume: 194

Technical Support Number: 1 800 227-2572

Table of Contents

My Treatment Parameters.....	2
Contents Quick Search	7
Introduction.....	12
Requirements.....	12
Indications for Use (Purpose of the Liberty cyclor)	13
Contraindications (When this machine should not be used).....	13
Peritoneal Dialysis Precautions	13
About This User’s Guide	14
Related Reading	15
Questions? Call Technical Support.....	15
General Warnings	16
Meet Your Liberty Cyclor.....	20
The Control Panel	24
The Status Bar.....	26
Touch Screen Buttons	28
Navigating With Screen-Buttons	30
The Pump Module.....	32
The Cassette and Tubing Set.....	34
The stay•safe System.....	36
The Heater Tray.....	38
Setting up Your Liberty Cyclor.....	40
Entering Your Prescription	44
Setting Your Treatment Parameters	46
Select Therapy Tab	48
CCPD: Treatment-Based Settings	50
CCPD: Cycle-Based Settings.....	52
IPD: Treatment-Based Settings.....	54
IPD: Cycle-Based Settings	56
PD+: Treatment-Based Settings	58
PD+: Cycle-Based Settings.....	60
Tidal: Treatment-Based Settings.....	62
Tidal: Cycle-Based Settings	66
Patient Settings Tab	70
Options Settings Tab	80
Hardware Settings Tab.....	82

Pre-Treatment Checklist.....	86
Starting Your Treatment.....	88
Preparing.....	92
Priming.....	102
Connecting Yourself.....	112
Exchanges.....	116
Exchange: Drain 0.....	118
Exchange: Fill1.....	120
Exchange: Pause.....	122
Exchange: Dwell.....	126
Ending Your Treatment.....	130
Your Treatment Summary.....	134
Power Down Cyclers.....	142
Appendix.....	146
The My Records Screen-Button.....	148
Using the STOP key.....	154
Using the STAT Drain.....	156
Bypassing an Exchange.....	158
Using the IQdrive.....	162
Moving Your Liberty Cyclers.....	166
Warnings and Alarms.....	170
Warning: The Help Button.....	174
Alarm: Red Status Bar.....	178
Troubleshooting.....	180
Different People Drain Differently.....	194
Power Failure.....	196
Cleaning Your Cyclers.....	202
Machine Specifications.....	204
Manufacturer's EMC Declaration.....	207
Product Improvement Policy.....	211
Warranty.....	211
Glossary.....	215
Index.....	219

This Page is Intentionally Blank

Introduction & Overview

Introduction

Enjoy the freedom of the new Liberty cyclor. We at Fresenius Medical Care know that life on peritoneal dialysis may be complicated, but we have worked hard to make it simpler. Your Liberty is light, portable, and easy to operate. It has an easy to load cassette and simple touch screen menus to guide you through setup and treatment procedures. Carefully following your doctor's instructions, you have the convenience and freedom of peritoneal dialysis at your fingertips. Be sure to read and follow all instructions and warnings listed in the manual.

Requirements

Operators of your Liberty cyclor machine must be trained to perform peritoneal dialysis under the direction of a physician. In addition, each operator should be:

- Knowledgeable of peritoneal dialysis procedures and how they affect the body
- Well-practiced in aseptic techniques and other peritoneal dialysis procedures
- Very familiar with the contents of this manual
- Fully trained and qualified to operate this machine. You and any other user must be able to tell between normal and abnormal operation.

Indications for Use (Purpose of the Liberty cyclor)

The Liberty cyclor is indicated for short term (acute) and long term (chronic) peritoneal dialysis.

The Liberty cyclor can provide the following therapies: continuous cycling peritoneal dialysis (CCPD), intermittent peritoneal dialysis (IPD), peritoneal dialysis plus (PD+), and tidal peritoneal dialysis (TPD).

Contraindications (When this machine should not be used)

CAPD and CCPD are effective and attractive choices for many ESRD patients; however, no one dialysis therapy is right for all patients. The following health problems likely prevent or impair you from using the Liberty cyclor:

- Leaks across the inside of your body's lining (Transdiaphragmatic leakage)
- A destructive metabolism (hypercatabolism)
- Too little peritoneal membrane surface area
- Multiple abdominal surgeries

This is a guideline only. Your doctor must make the final decision whether or not any medical device is appropriate for you.

Peritoneal Dialysis Precautions

Your doctor has prescribed peritoneal dialysis (PD) for you. There are risks to PD, but your doctor feels it is better to perform PD than not. Here are some things your doctor should consider:

You must perform PD treatments according to the prescription given to you by your physician and the manufacturer's instructions. Not doing so, can sometimes result in harm. Abdominal pain, bleeding, infected peritoneal membrane (peritonitis), and a blocked catheter can cause problems with your treatment. Some dialysate solutions are stronger (higher percentage of dextrose) than others at removing fluids. It is important to use the right dialysate solution for your needs: the wrong dialysate solution may pull too much fluid (hypovolemia/dehydration) out of your body and cause low blood pressure (hypotension) or muscle cramping. Or it may pull too little fluid (hypervolemia) and cause high blood pressure (hypertension) or swelling (edema). You must continue to correctly remove fluid from your body.

You and your PD nurse must work together to monitor your weight and blood chemistry levels. You must pay close attention to how you feel and report any changes to your PD nurse. This will help prevent such complications as congestive heart failure, volume depletion, overfill of solution, shock, and inadequate therapy. Follow your doctor's prescription and instructions to reduce the risk of these problems that could result in serious complications.

Caregivers should carefully monitor patients for the above signs and symptoms.

About This User's Guide

This user's guide is a reference for properly trained home users of the Liberty cyclor—it cannot replace formal training by your healthcare staff. It cannot provide or replace clinical advice.

This manual is specially designed for easy readability and understanding. It has illustrated procedures and step-by-step instructions.

Follow your machine's on-screen instructions. Use this manual only as a guide for your machine's screens. You should read the entire user's guide before beginning your treatment. Take note of attention boxes, explained below:

Attention Boxes



Warning: This symbol warns against an action or situation that could hurt you. If you do not follow these instructions, it can lead to serious injury or death.



Shock Hazard: This symbol means you could get a severe electrical shock if you use the equipment wrong.



Caution: This symbol means you will damage your machine if you do not follow instructions.



Note: This symbol means there is extra information about machine features. Notes have helpful information. They may also show instructions for unique cases.

Other Important Symbols



Degree of protection against electric shock: Type BF



ON: This symbol, at the top of the switch on the back of your machine, means the switch is in the ON position.



OFF: This symbol, at the bottom of the switch on the back of your machine, means the switch is in the OFF position.

Related Reading

These documents have more information about your Liberty cycler:

- Liberty Cycler Initiation of Treatment Procedure Card (P/N 480039)
- Liberty Cycler Handi-Guide (P/N 480040)
- Liberty Cycler Field Service Bulletins may be obtained from the Fresenius Medical Care website: www.FMCNA.com or contact your healthcare professional for more information.
- Preventative Maintenance Requirements (09-PD-001)
- Contact Fresenius Medical Care Quality Systems for information on test procedures to verify sterile items

Questions? Call Technical Support

If you have any questions, please call Fresenius Medical Care Technical Support anytime at **1 800 227-2572**.

General Warnings

Read all the warnings before beginning your treatment. Additional warning statements for each topic are found throughout the manual.



Warning: Read this entire user's guide before beginning your treatment. You must be familiar with how to use your machine and with the features of this manual. If you do not follow these instructions to install and maintain this equipment, it may cause serious injury or death.



Warning: Your doctor must prescribe your entire treatment. If you use incorrect values, it may cause serious injury or death. Do not use example values shown in machine pictures.



Warning: Check for proper functioning of your machine before beginning your treatment. Alarm failure or unidentified problems could lead to serious health risks.



Warning: Keep fingers clear of moving parts.



Warning: The Liberty cyclor is not sterile equipment. Only the interior of the tubing sets are sterilized. You must use aseptic technique (masking and handwashing) as directed by your PD nurse to prevent infection. Infections may cause serious injury or death.



Warning: Check the heater tray to be sure it is free of obstructions and does not touch the top of your cyclor cabinet. Interference with the heater tray may result in inaccurate dialysate weighing and possibly result in patient injury.



Warning: Explosion Hazard. Do not use in the presence of flammable substances like anesthetics.



Warning: Check that all tubing is free from kinks or damage before beginning treatment.



Warning: Do not use damaged cassettes for your treatment or allow any liquid to drip in or on your machine. Spills from your treatment can lead to serious injury or death. If spills occur, you must contact Technical Support immediately. Do not attempt to clean or disinfect leaks inside your cyclor.



Warning: You must clean your machine to prevent contamination and infection.



Warning: Do not use devices emitting strong electromagnetic radiation such as portable phones, radio equipment (walkie-talkies, etc.), radio transmitters, and like equipment near your machine. Improper operation may result. Digital phones may be conditionally allowed. Discontinue use of any device if any interference is noted, such as false pressure readings that disappear when the external signal is removed.



Warning: Overfilling or Increased Intraperitoneal Volume (IIPV) of the peritoneal cavity is when you have an amount of fluid in your abdomen that is larger than your prescribed fill volume: IIPV may result in serious injury or death from conditions such as: abdominal wall and/or diaphragmatic hernias, hydrothorax, heart failure, acute hypertension, pulmonary edema, decreased pulmonary function and pericardial effusion.

Patients and caregivers should watch for the potential signs of IIPV. These include: difficulty breathing; vomiting or spitting up; feeling full, bloated, or overfilled after treatment; abdominal pain or discomfort; expanded or tense abdomen; localized swelling around the genital area, navel, or tunnel tract of the peritoneal dialysis catheter or the PD catheter exit site; leakage of fluid from the PD catheter exit site; and unexpected increase in blood pressure. Contact your doctor or PD nurse if any of these symptoms occur.

If you experience any of these symptoms or feel a large, painful build-up of pressure during your fill, do not finish your fill cycle. You must press the **STOP** key to stop your cycler immediately then call your PD nurse or doctor, see page 156 for more information. Overfilling can cause serious injury or death.



Warning: If you have no Last Fill programmed on your cycler and you did a manual Fill during the day, your cycler does not know that you must drain additional fluid. If your catheter line then gets kinked during Drain 0 and the draining stops, your cycler may advance to Fill 1 before you have finished draining. This may cause an overflow situation which may lead to serious injury or death. Always make sure that you have drained enough during Drain 0 when your cycler starts Fill 1.



Warning: Shock hazard. Do not remove machine cover. Refer servicing to qualified personnel. The electrical source must be single phase, three-conductor type at 120/250 VAC 50/60Hz. Your cycler needs a protective earth electrical ground connection. The outlet you use for your cycler must be checked and maintained for a good ground connection to protect you from risk of electrical shock.



Warning: Shock hazard. The machine must be plugged directly into an electrical outlet; do not use extension cords or power strips. Do not use power cords other than those provided with your cyclor. If you must connect your cyclor to a 240V power source, contact Technical Support for a power cord rated for 240V.



Caution: Do not place your cyclor near external heating or cooling sources like heaters or air conditioners.



Caution: Your Liberty cyclor contains an internal battery. This battery requires no periodic maintenance by the user and should not be replaced by the user.



Caution: Your Liberty cyclor is a computer controlled electro-mechanical medical device. It should be installed in an appropriate environment (indoors) free from extremes of temperature and humidity and reasonably protected from dust and dirt contamination or liquid splashes. Failure to install your Liberty cyclor according to these guidelines may result in improper operation or early failure of the device or its parts.



Caution: The maximum total weight on your cyclor's load scale is 15 kg (33 lbs.) or three 5000 mL solution bags. Overloading the scale can cause damage to your cyclor's load cell.



Caution: Use only cyclor tubing sets intended for the Liberty cyclor.



Caution: Use only your fingertips on the Touch Screen and cyclor keys. Use of other objects, such as pens, may result in damage or premature failure.



Caution: The cassette door is pressurized. Do not attempt to open the cassette door until your machine instructs you to do so.



Note: Your machine's operation involves fluids: accidental spills can occur. Spills can cause damage to carpeting and other surfaces. To contain such spills, your machine should be on a spill-tolerant surface. Clean up spills immediately.



Note: This manual shows tubing set model 050-87212 which has two stay•safe connectors on the patient line. If you use a different tubing set, your healthcare staff is responsible for providing alternate instructions.

Fresenius Medical Care manufactures tubing sets for use with the model Liberty cyclor. The performance of tubing sets not manufactured by Fresenius Medical Care cannot be guaranteed by Fresenius Medical Care and are therefore the responsibility of the prescribing physician.

This Page is Intentionally Blank

Meet Your Liberty Cyclor

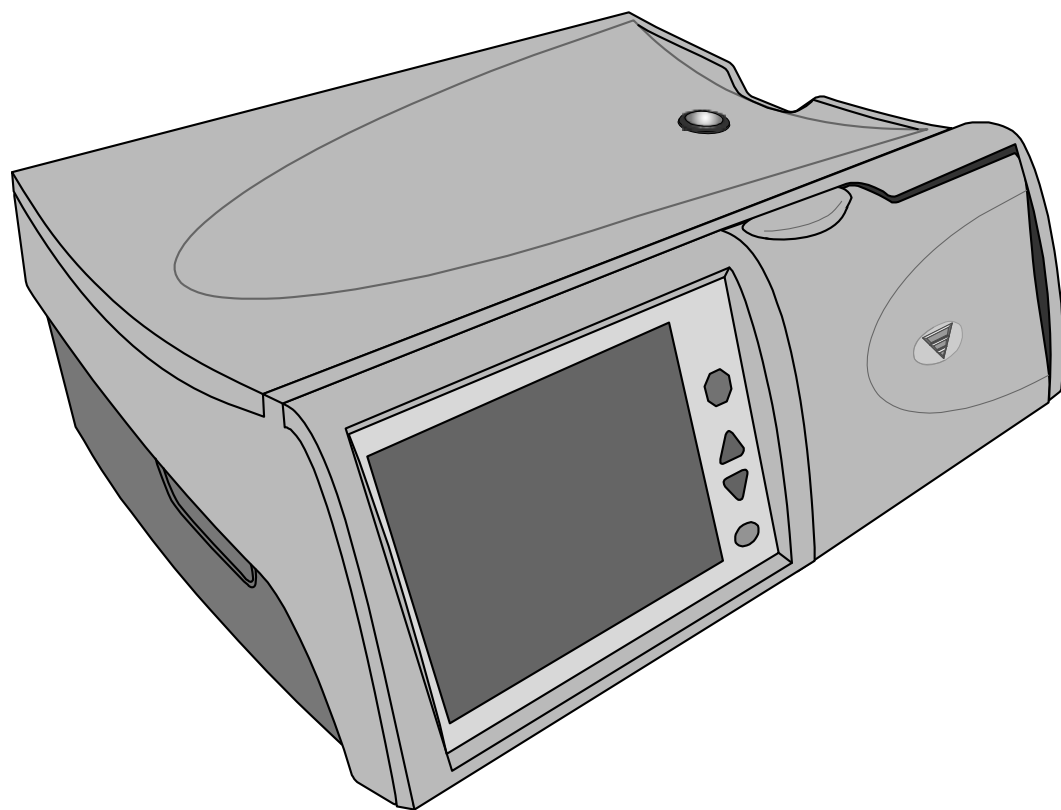

Liberty Cyclor Features

Your Liberty cyclor helps your body to do the work of your kidneys. Your cyclor pumps dialysate (a cleansing solution used to draw waste products and extra fluids out of your blood) into your empty peritoneal cavity. There it absorbs waste through your body's natural membrane over a set amount of time. When that time has expired, your cyclor drains the waste from your body. Your machine repeats this as often as your doctor prescribes. All dialysate and waste pass through a disposable sterile tubing set that is discarded after each treatment.

Your Liberty cyclor offers four different types of therapy. They fit into two groups: *Continuous Therapy* and *Intermittent Therapy*.

In *Continuous Therapy* you continually have dialysate dwelling your peritoneal cavity. CCPD and PD+ are both continuous therapies.

In *Intermittent Therapy* you may either be empty or have only a small amount of dialysate in your peritoneal cavity at certain times. Tidal and IPD are usually intermittent therapies.

For more information about these therapies, see page 116.

This manual features treatment walkthroughs for each type of dialysis therapy. Please read the entire manual to learn about the features of your Liberty cyclor before beginning your treatment.

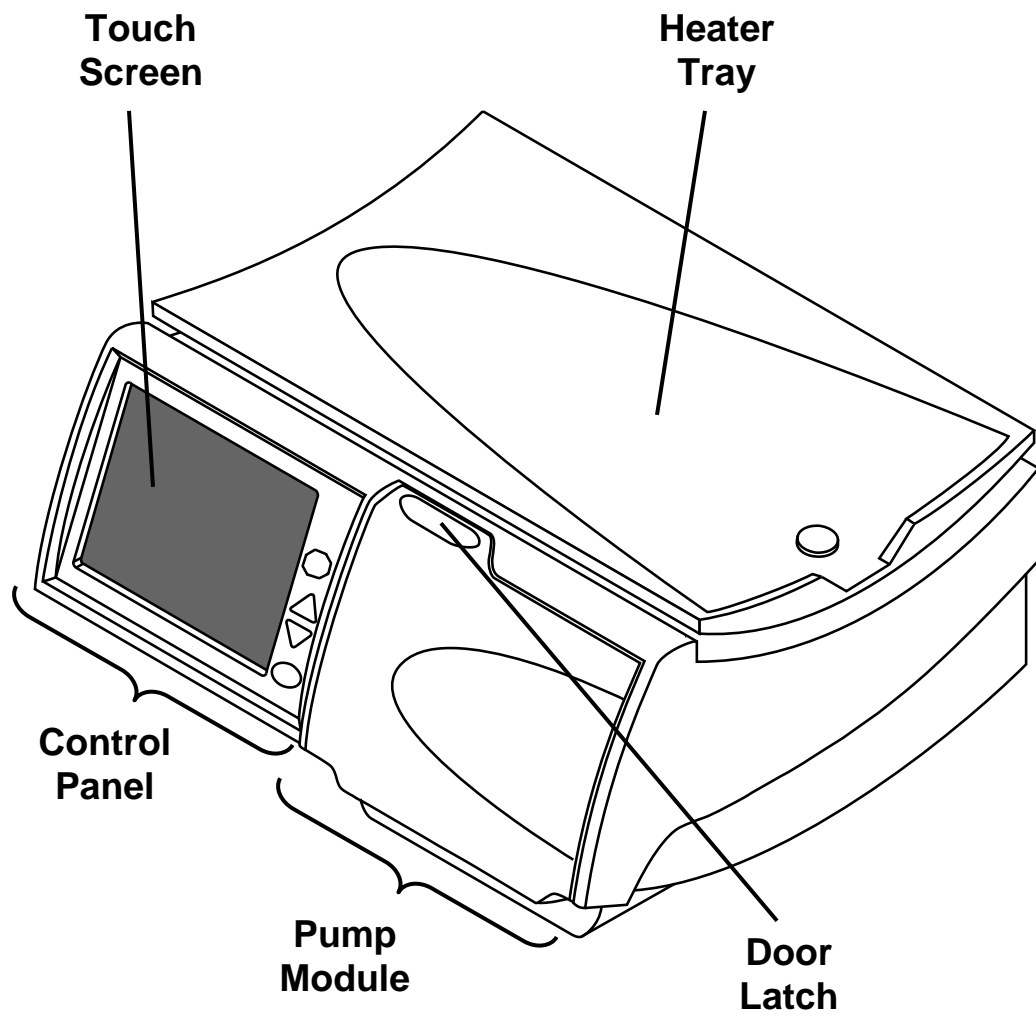

Your Liberty Cycler - Front View

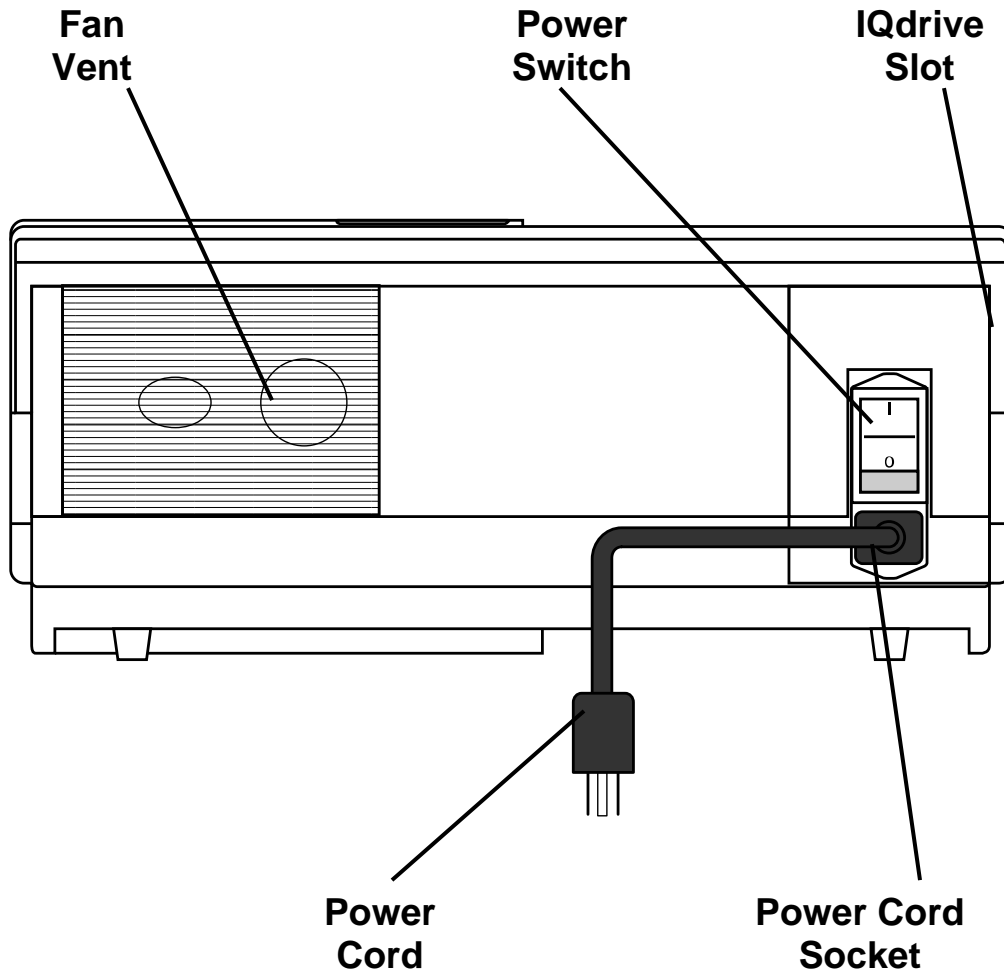

Your Liberty Cycler - Rear View

The Control Panel

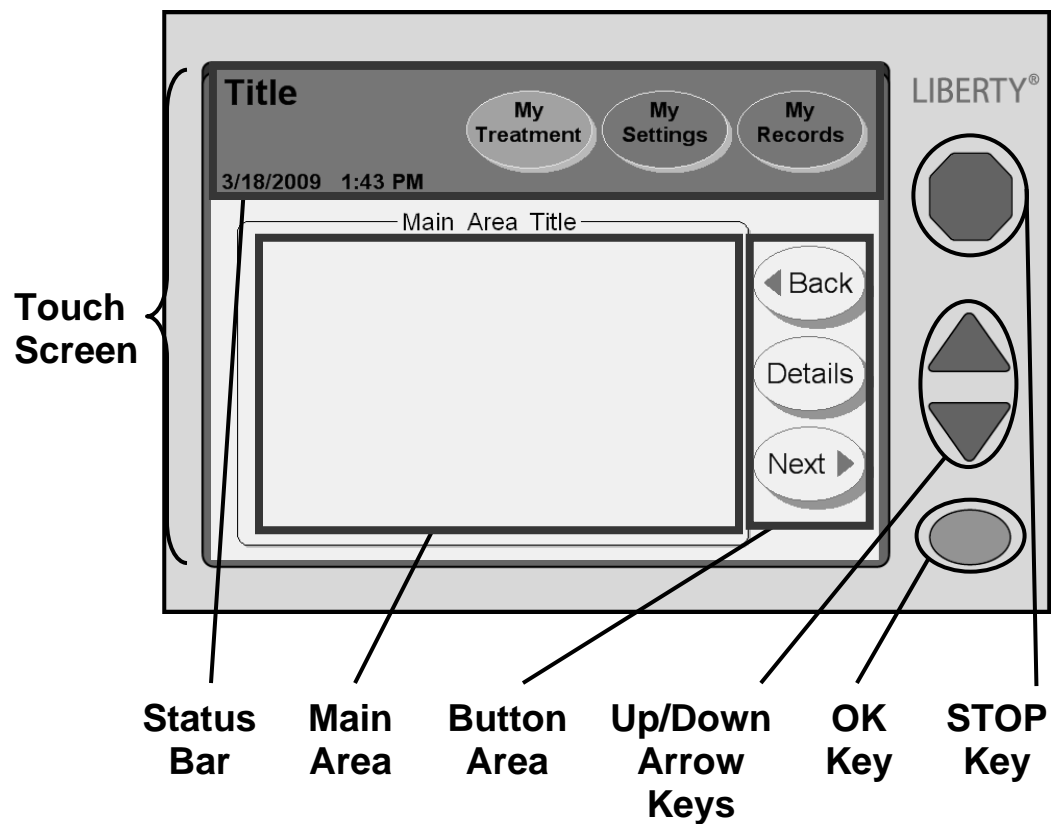

Control Panel

The Control Panel contains all the keys and buttons you need to set up and run your treatment.

Touch Screen

The Touch Screen is a viewing screen that reacts to fingertip pressure. Using the Touch Screen, you may monitor your treatment and select treatment options with Touch Screen Buttons. The different types of Touch Screen Buttons are described on page 28. The Touch Screen may be set to automatically blank the screen after ten minutes to darken the room for sleep (see “Hardware Settings” on page 82). Touch anywhere on the screen to restore the display when desired.

Status Bar

See page 26 for a description of the Status Bar.

Main Area

The Touch Screen Main Area shows information and procedures. You may also make treatment selections there.

Button Area

The Button Area contains movement-buttons like **Next**, **Back**, and **Details**.

Up/Down Arrow keys

The **Up/Down Arrow** (▼/▲) keys are used to raise or lower button values.

OK key

The **OK** key confirms Touch Screen selections. In treatment procedures, the **OK** key also moves you to the next step. During certain actions like Drain and Fill, you may use the **OK** key to bypass that action. Press and hold the **OK** key for about four seconds to display the “Bypass” screen. There you may choose to bypass a phase of your treatment or not (see page 158 for more information).

STOP key

The **STOP** key stops functions on your machine. Pressing the **STOP** key during an audible alarm will silence the alarm for ten minutes.

The Status Bar

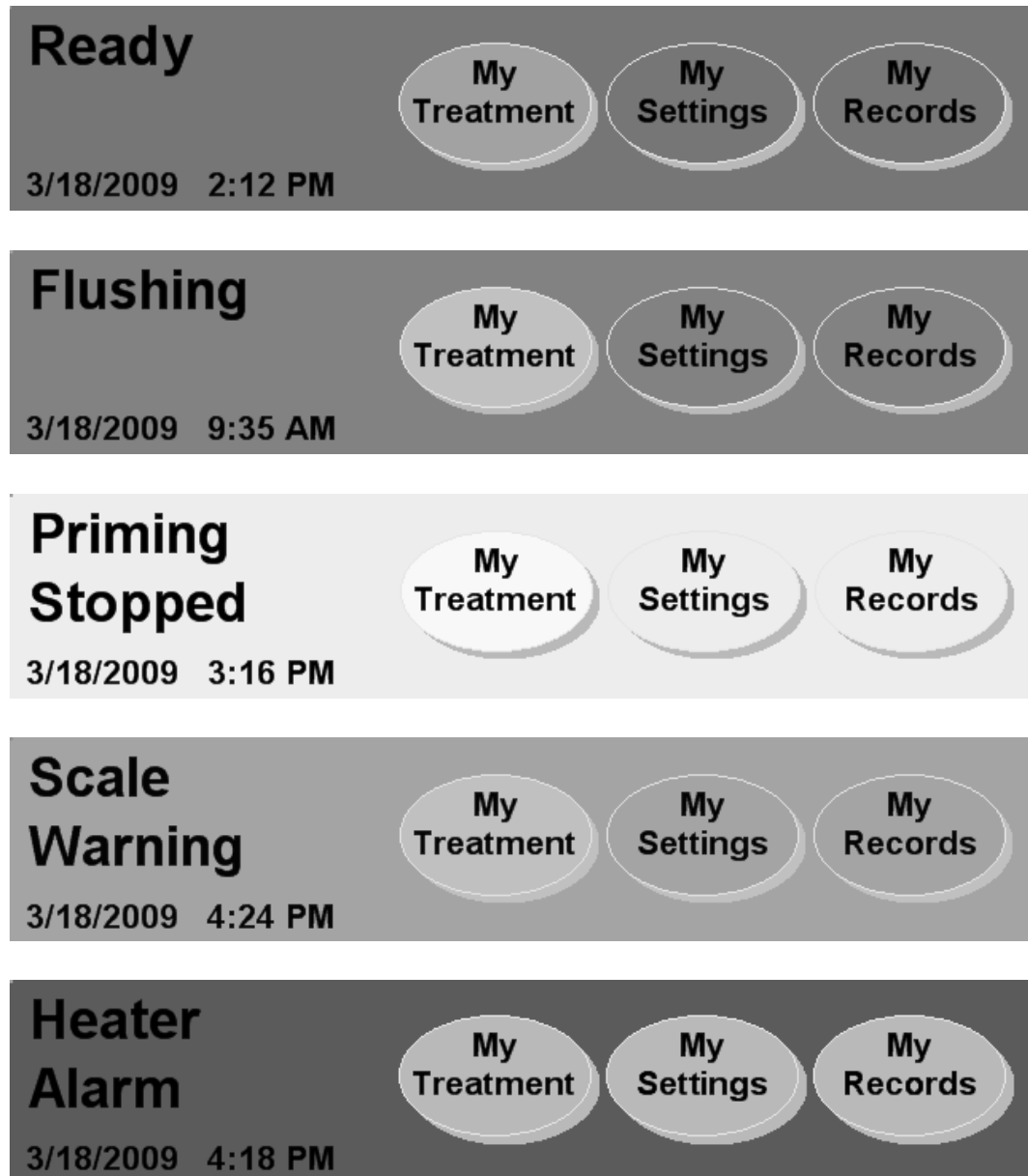

Status Bar

The Status Bar is located at the top of the Touch Screen. It displays various modes, warnings, alarms, and the date and time. The Status Bar background changes between five different colors to display your machine's conditions (as shown to the left):

Blue

During normal operation, when no problems have been detected or when no actions (see Green) occur, the Status Bar background is blue.

Green

When your machine is performing an action such as fill, flush, prime, pause, dwell, or drain, the background changes to green.

Yellow

The background changes to yellow whenever you press the **STOP** key during an action (see Green). See "Using the STOP key" on page 154.

















Orange

Orange warnings need your immediate attention. During a warning, the Status Bar background changes to orange, the screen-buttons are unavailable, all actions stop, and an audible alarm sounds. Press the **STOP** key to silence the alarm.

Red

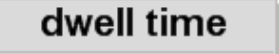
Red background alarms are critical faults in your machine. All actions stop, the screen-buttons are unavailable, and an audible alarm sounds. If the Status Bar changes to red, you must stop your treatment and call a technician. For more information on alarms, see "Warnings and Alarms," on page 170.

Touch Screen Buttons

	Normal Bright color or background color	Selected Darker color or lighter background color	Unavailable or Display Only Gray or light blue
Screen -Buttons			
			
Movement -Buttons			
			
Parameter -Buttons			
			
			



Note: The values shown here are for example only. You must use the values prescribed by your doctor.

Buttons Overview

Buttons are shapes with text in them on the Touch Screen. Buttons perform certain actions when touched.

Screen-Buttons

Screen-buttons are oval shaped. They are usually located along the top of the Touch Screen in the Status Bar. Screen-buttons act as a ‘doorway’ to another set of screens. When you touch a screen-button, it turns to a lighter color and its screen is displayed. Screen-buttons are the same color as the Status Bar’s background. Grayed-out screen-buttons are unavailable. Screen-buttons also appear in the “Settings” screen as tabs along the top of the Main Area. See the next page for more information about each of the Status Bar screen-buttons.

Movement-Buttons

Movement-buttons are light-blue, oval shaped buttons. They are usually located in the button area of the Touch Screen. Movement-buttons move you from a screen to its sub-screen and back. For example, in a “Treatment” screen, the Details movement-button will move you to a screen showing the “Treatment” screen’s details.

Parameter-Buttons

Parameter-buttons are light yellow rectangles that display treatment values. When you touch a parameter-button, it turns orange, allowing you to edit the parameter it displays. Depending on the button, you may edit that parameter either directly or through another screen using other keys and buttons. Grayed-out parameter-buttons are unavailable options. Blue parameter-buttons are not editable, they display parameters affected by other active parameter-buttons.

Navigating With Screen-Buttons

The screenshot shows a mobile application interface. At the top left, the title 'My Settings' is displayed. To its right are three circular buttons labeled 'My Treatment', 'My Settings', and 'My Records'. Below the title, the date and time '1/24/2008 3:27 PM' are shown. A horizontal row of four buttons labeled 'therapy', 'patient', 'options', and 'hardware' is positioned below the date. A large rounded rectangle contains a form with the following fields:

your first name	
John	
your last name	
Smith	
your ID	weight
123456789	155 lbs
date of birth	gender
04/29/1959	Male

Screen-buttons



Note: The values shown here are for example only. You must use the values prescribed by your doctor.

My Treatment

The **My Treatment** screen-button runs your selected treatment procedure. See “Starting Your Treatment,” on page 88, for more information.

My Settings

The **My Settings** screen-button allows you to edit various settings. In the “Settings” screens, you may enter treatment parameters, patient information, and software and hardware options. See “Setting Your Treatment Parameters,” on page 46, for instructions on entering your treatment parameters.

My Records

The **My Records** screen-button allows you to view your current treatment data and treatment data from past treatments. For more information, see “The My Records Screen-Button,” on page 148.

The Pump Module

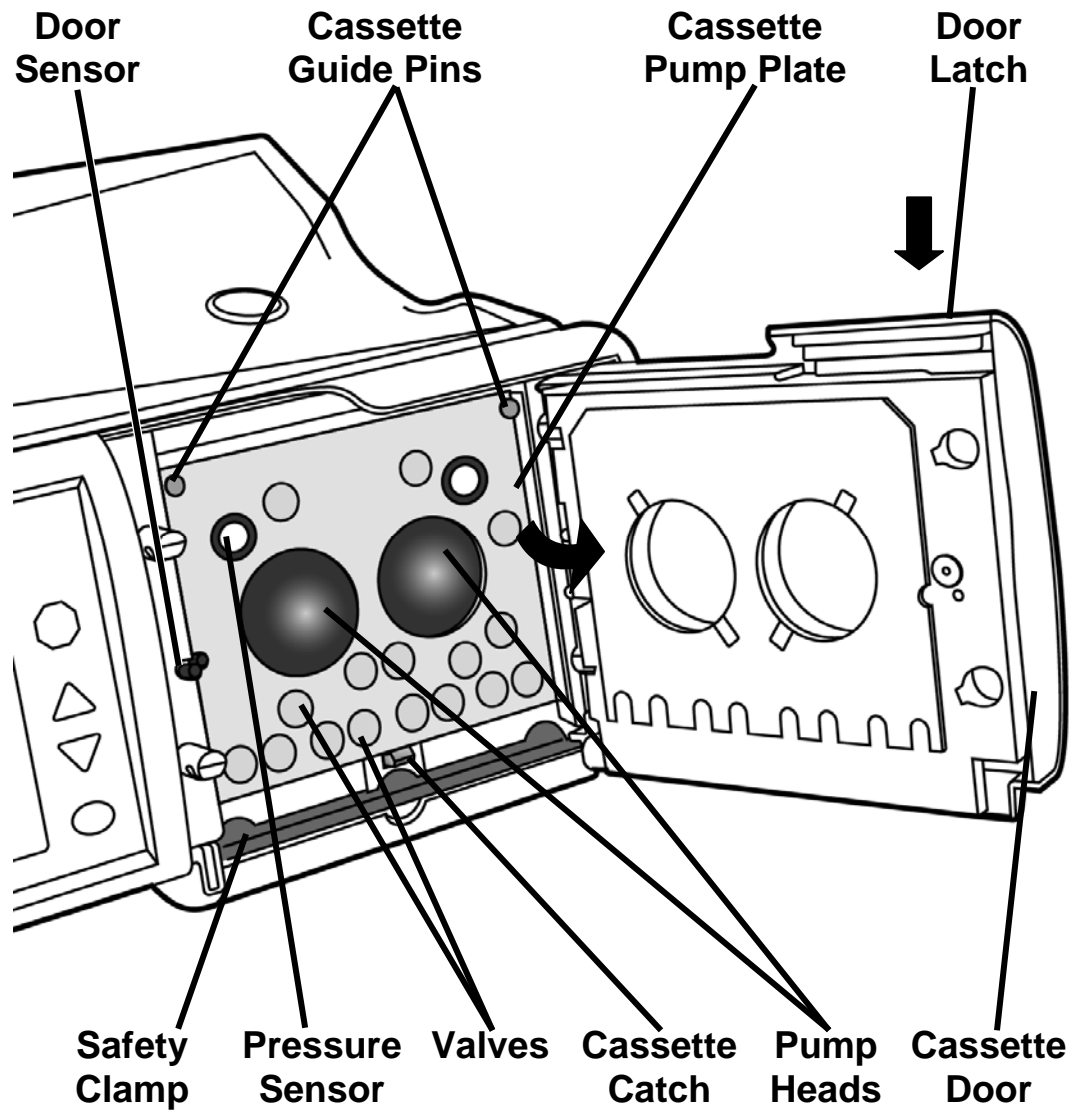

Pump Module

The Pump Module is responsible for moving dialysate solution to and from your body. It controls the valves and pumping chambers in the cassette.

Door Sensor

The Door Sensor tells the machine when the door is open or closed.



Caution: Do not touch the door sensor. Doing so will cause your machine to sense a closed door, pressurizing the cassette door.

Safety Clamp

The Safety Clamp is a metal bar that instantly clamps all the cassette tubing during an alarm.

Pressure Sensors

The Cassette Pump Plate also features two white pressure sensors to monitor you during treatment.



Caution: Do not touch the white pressure sensors in the Pump Module. Pressing on the pressure sensors may damage them.

Cassette Guide Pins and Cassette Catch

When the cassette is inserted during treatment, it fits up against the metal pins at the top of the Cassette Pump Plate. At the bottom of the Cassette Pump Plate, the Cassette Catch holds the bottom of the cassette in place.

Cassette Pump Plate

The Cassette Pump Plate is a thick metal partition. The pumps and valves are located behind the plate and they push through the holes in it to compress the cassette.



Caution: When the cassette is properly inserted in your machine, the domes will face outward. If you insert the cassette in your machine the wrong way, it may damage your machine.

Cassette Door

The Cassette Door holds the cassette in place against the Cassette Pump Plate when locked.

Door Latch

The Door Latch locks the Pump Door. During treatment, do not attempt to unlatch the Pump Door unless instructed to do so.



Warning: Keep fingers clear of moving parts.

The Cassette and Tubing Set

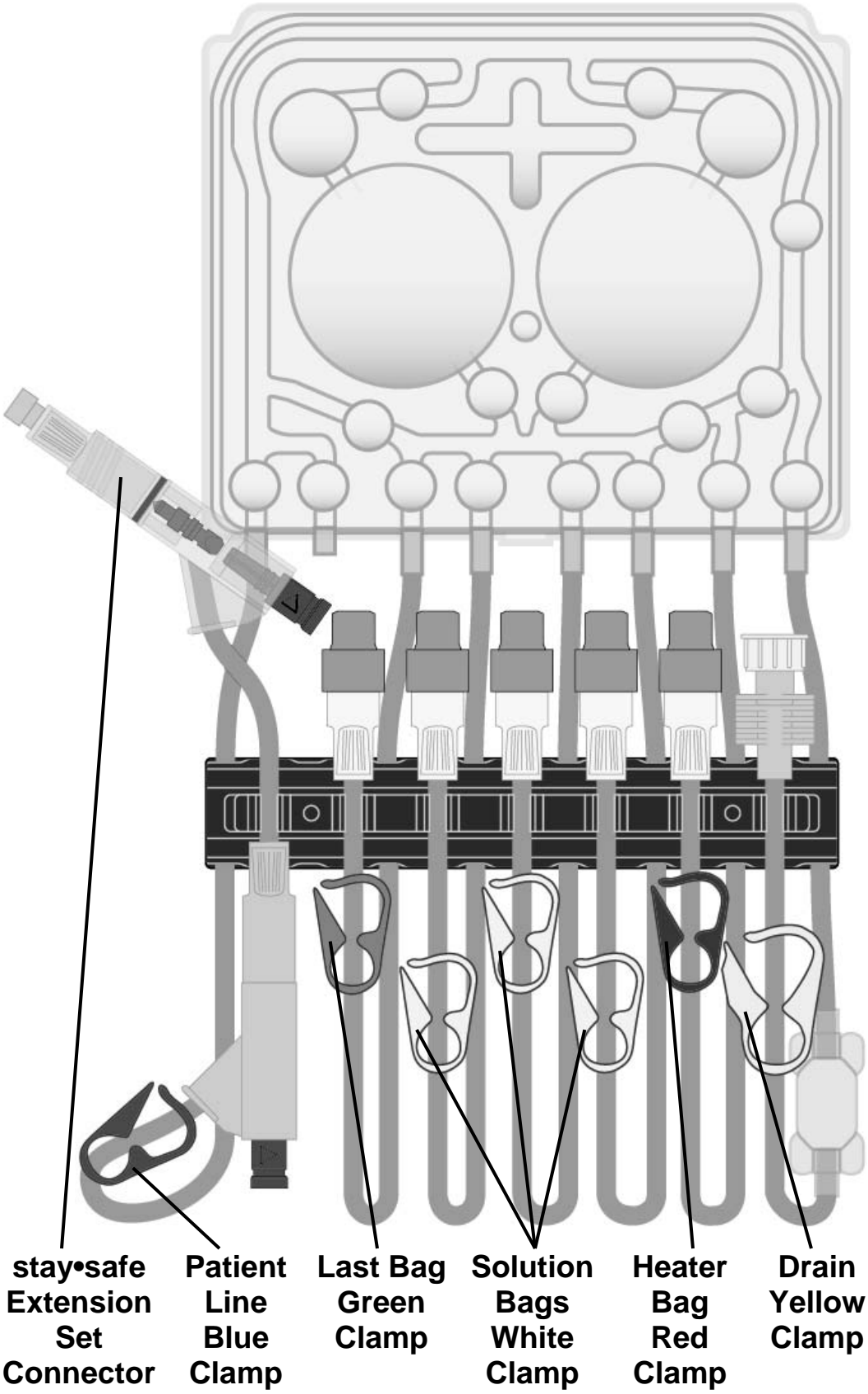

Cassette

All dialysate and waste pass through a disposable sterile tubing set that is discarded after each treatment. The hard plastic piece that is inserted into your cyclor is called a cassette. The cassette has two large, plastic domes. When the cyclor pushes in on the membrane behind them, fluid moves through the lines. The cassette also has smaller domes or valves that, when compressed, close a fluid pathway.

Below the cassette is an attached tubing set that varies by model number. A dark blue tubing organizer holds each of the following lines in place while you connect:

stay•safe Extension Set Connector

The stay•safe connector is on the blue Patient Line. There is a blue pin trigger at the end and a blue pin inside the connector. When you press the blue pin trigger, the pin inside closes the line without you having to touch it.

Blue Patient Line

The blue Patient Line has a blue clamp. It connects to your catheter extension set.

Green Last Bag Line

The Bag 4 Line has a green clamp. It connects to your last bag if needed. The last bag may be used for more solution or a different solution for your last fill.

White Solution Bag Line 3

The Bag 3 Line has a white clamp. It connects to your third bag if needed.

White Solution Bag Line 2

The Bag 2 Line has a white clamp. It connects to your second bag if needed.

White Solution Bag Line 1

The Bag 1 Line has a white clamp. It connects to your first bag if needed.

Red Heater Bag Line

The Heater Bag Line has a red clamp. It connects to the dialysate solution bag on the Heater Tray.

Yellow Drain line

The Drain Line has a yellow clamp. It connects to your drain line or, if desired, the drain bag set. The drain line also has a clear 'pillow' that allows you to check the fluid for clarity or fibrin as it is pumped to the drain.

The stay•safe System

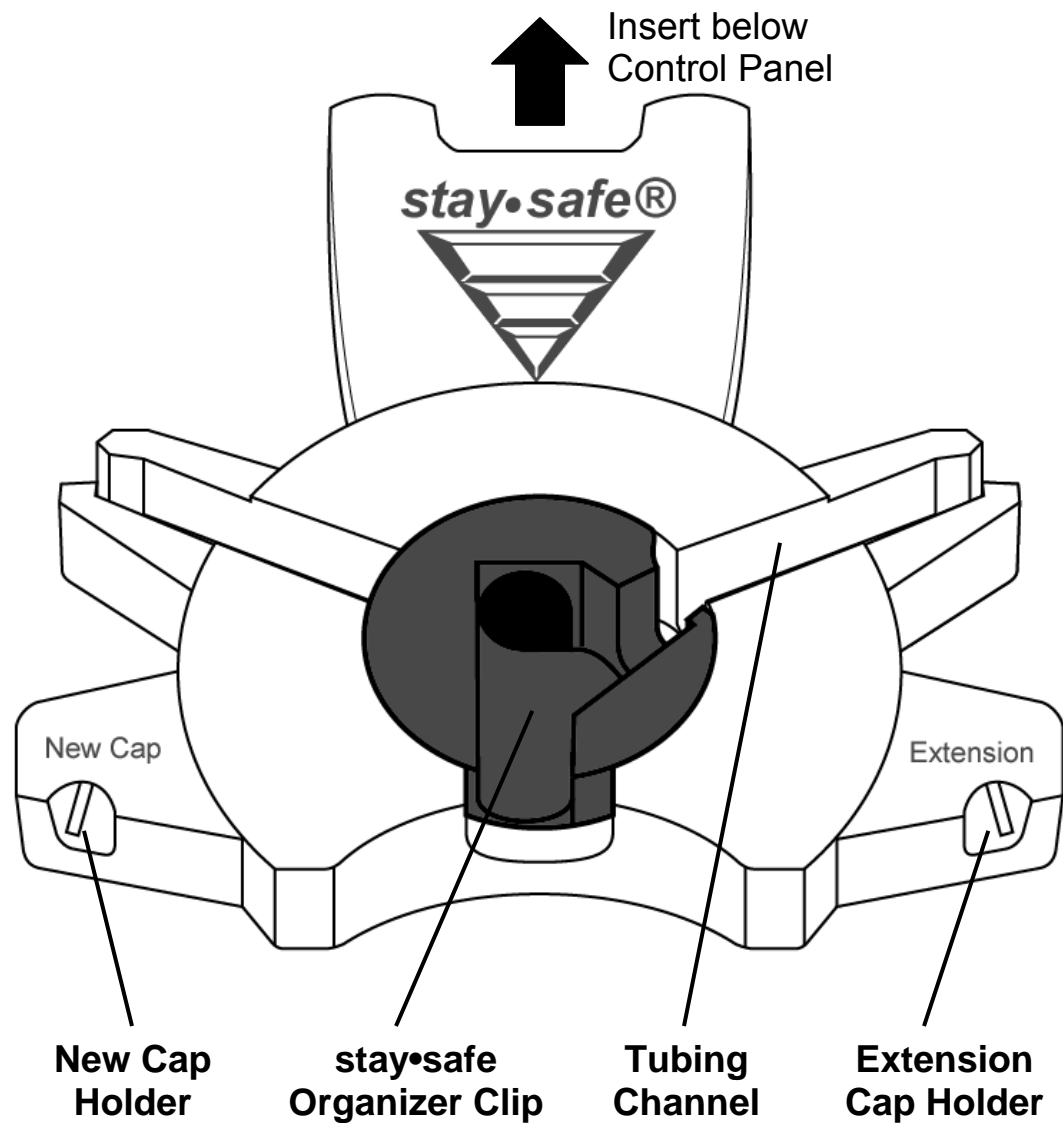

The stay•safe System

When you use aseptic technique in your treatment, you reduce the risk of infections. The stay•safe system helps you use aseptic technique. Insert the stay•safe system onto the mounting tab on your cyclor below the Control Panel. Your stay•safe system will be ready to hold your stay•safe connector during your treatment setup. For more information about the stay•safe connector, see page 34.

New Cap Holder

Insert a new stay•safe cap into this holder to keep it clean while using both hands to set up your lines. This is a reminder to help you remember to always use a new stay•safe cap.

stay•safe Organizer Clip

The stay•safe connector part of the blue patient line fits into this holder. The organizer clip keeps it in place so you can connect yourself to it when your cyclor instructs you to.

Tubing Channel

The tubing that leads to the cassette goes here. When you place the tubing in the Tubing Channel, it helps hold the line in place. Be sure to press the tubing in firmly to prevent it from popping out of the tubing channel.

Extension Cap Holder

The Extension Cap Holder holds a used cap in place as you remove it from the end of your extension line. Insert the used cap while connected, untwist it, and connect the line to a new stay•safe connector.

The Heater Tray

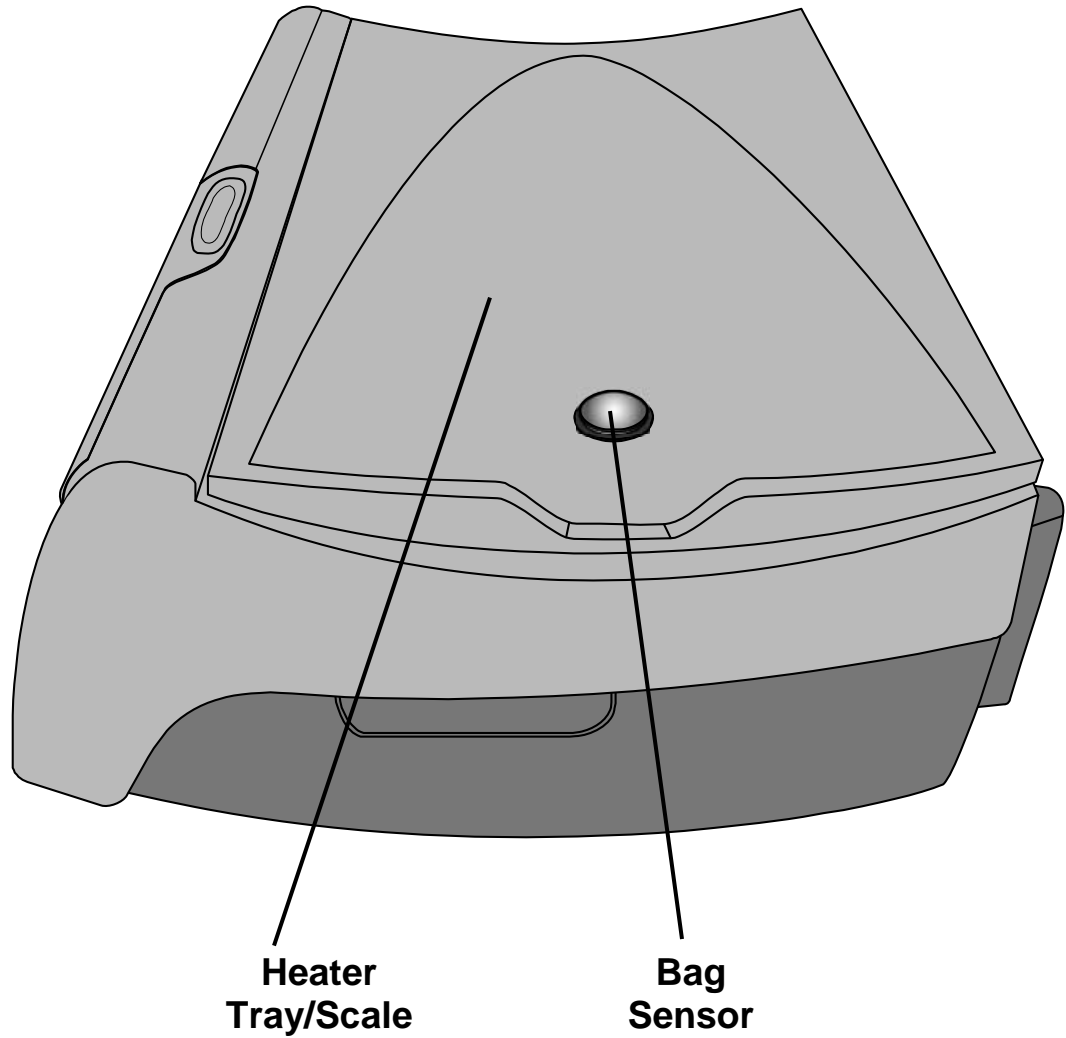

Heater Tray/Scale

The Heater Tray warms the dialysate solution-filled heater bag to a set temperature in about 20 minutes. The Heater Tray also operates as a scale, weighing the heater bag.



Warning: Make certain that the Heater Tray is free of obstructions and does not touch the top of your cyclor's cabinet (there should be an even gap all the way around the Heater Tray). Interference with the Heater Tray may result in inaccurate dialysate weighing and possible patient injury.

Warning: During the heating process, the Heater Tray can get as hot as 50 °C (122 °F). Do not come into contact with the Heater Tray as it may cause injury.



Caution: Do not lift your machine by the heater tray/scale. Doing this may damage the scale.

Caution: Do not place items other than solution bags on the Heater Tray.

Caution: Do not overload the scale. Weight greater than 15 kg (33 lbs.) or three 5000 mL solution bags may damage your machine.

Bag Sensor

The Bag Sensor measures the temperature of the dialysate solution heater bag.

Setting up Your Liberty Cycler

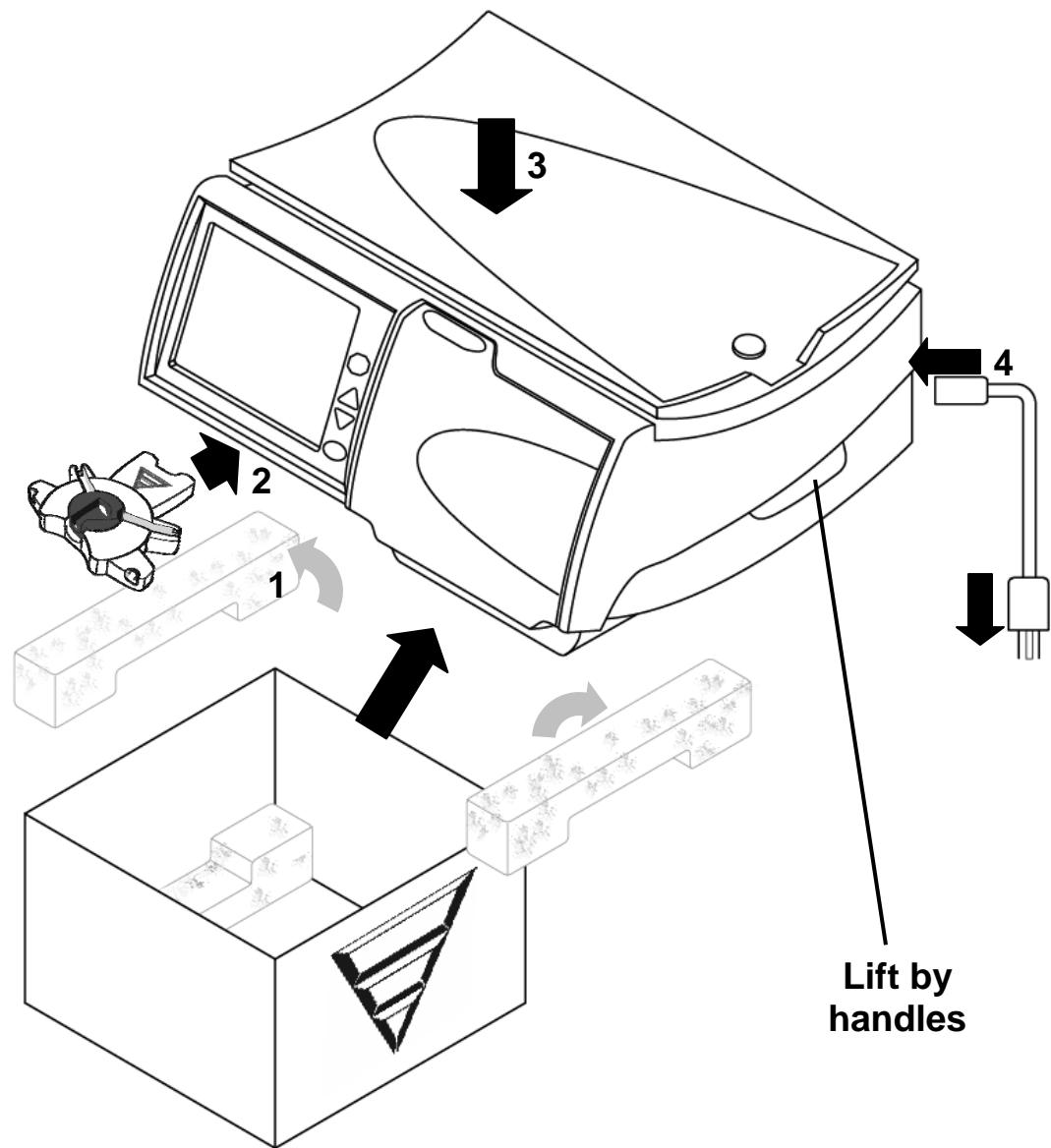

Setting up your Liberty Cyclor

Your Liberty cyclor is easy to set up. Follow the instructions below:

1 Remove your Liberty cyclor from box

- Pick up your cyclor by both handles on either side.
- Carefully lift your cyclor out of its shipping box. Set it on a stable, level surface such as a table with the screen facing you.
- Remove the protective foam on either side of your Liberty cyclor. Keep all foam and packaging in case your cyclor needs to be repacked.
- Position your cyclor near the edge of the table or cart so the tubing from the cassette will be able to hang down without kinking.



Warning: Use proper lifting techniques: lift with your knees and not your back.



Caution: Do not lift your machine by the heater tray/scale. Doing this may damage the scale.

Caution: Make certain the vent on the back of your machine is free of obstructions.

2 Connect stay•safe system

Push the stay•safe system onto the mounting tab below the Control Panel.

3 Check heater tray on cyclor cabinet



Warning: Make certain that the Heater Tray is free of obstructions and does not touch the top of your cyclor's cabinet (i.e. there is a level gap between the tray and the cabinet all the way around the cyclor). Interference with the Heater Tray may result in inaccurate dialysate weighing and possible patient injury.

4 Plug in machine

Plug the machine end of the power cord firmly into the power socket on the back of your machine. Plug the outlet end of the cord into a 120V three-prong power outlet. See page 44 for a picture of the back of your machine.



Warning: If you are unable to insert the plug in its socket and an outlet, contact technical support. Do not alter the power cord. Your machine must be plugged directly into the electrical outlet; do not use extension cords or power strips.

This Page is Intentionally Blank

My Settings

Entering Your Prescription

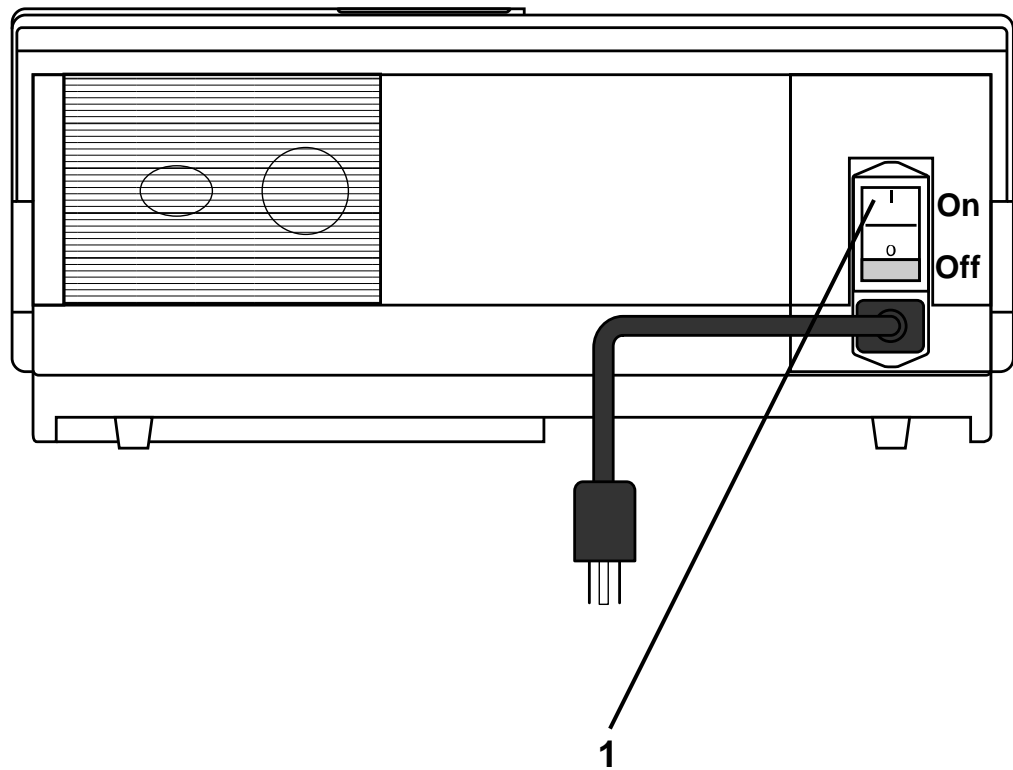

Entering your prescription

Before you start your first treatment, you will need to enter the treatment parameters that your doctor has prescribed. You do not need to do this again unless your prescription changes.

If your healthcare staff has provided an IQdrive and the USB option is set to YES (see “Options Settings,” on page 80), you may insert the IQdrive into the back of your machine at this time. See “Using the IQdrive,” on page 162 for more information on inserting the IQdrive.

The numbered items in the picture on the left match the numbered steps listed on this page. Do each step in order and pay close attention to Note, Caution, and Warning statements.

1 Flip power switch to ON

Locate the white power switch on the back of your machine and set it to the ON position. The “Ready” screen will appear on the Touch Screen shortly.

Setting Your Treatment Parameters

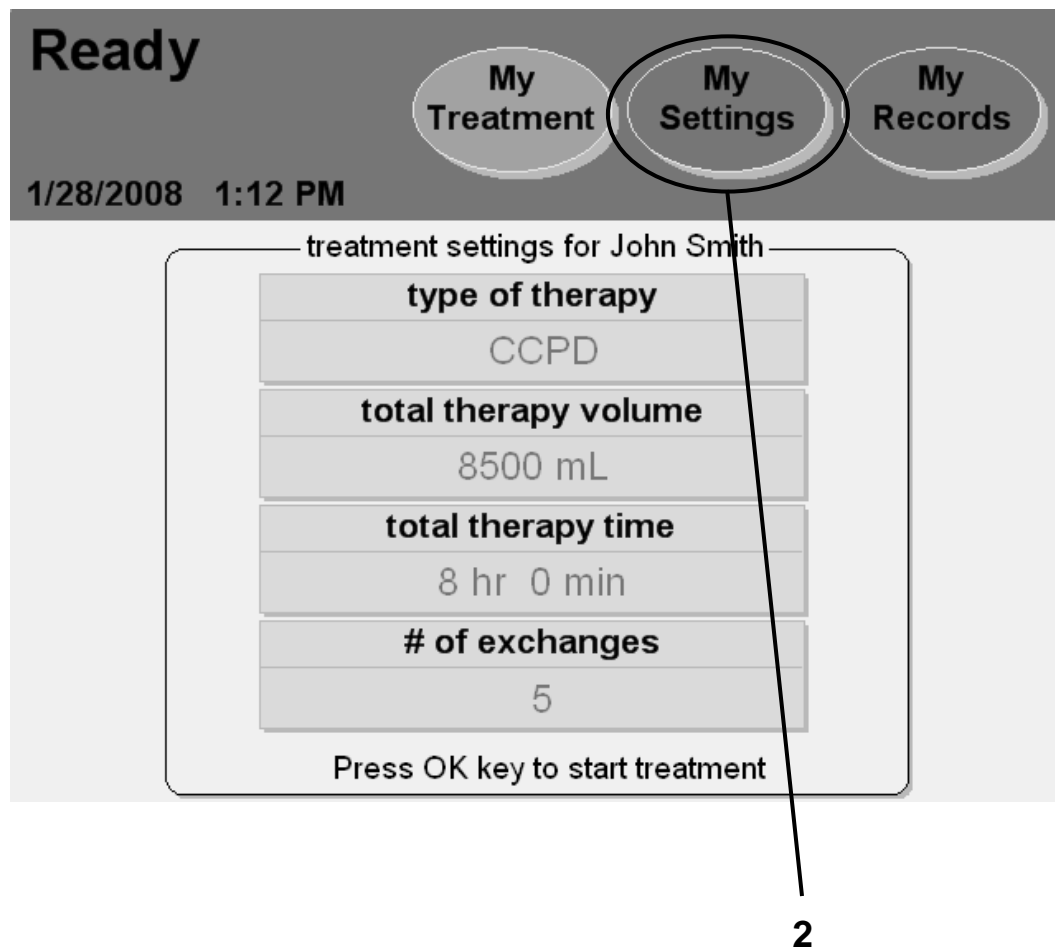

Note: The values shown here are for example only. You must use the values prescribed by your doctor.



Note: If your name and treatment parameters are already displayed on this screen, you do not need to enter them yourself. You may begin your treatment by turning to page 86.

2 Touch **My Settings**

The first time you start your machine, the “Ready” screen will display default treatment values for an “Unknown” patient.

Before you start your first treatment, you must enter your own prescribed treatment parameters if they have not been programmed with the IQdrive. Use the parameters from the “My Treatment Parameters” sheet on page 2, or follow your healthcare staff’s instructions.

To begin entering your treatment settings, touch the **My Settings** screen-button. You will then go to the “My Settings” screen.



Note: If the ‘USB enabled’ option under “My Settings: Options” is set to YES and an IQdrive is correctly inserted into the IQdrive slot on your cyclor, this screen might not be immediately displayed. See “Using the IQdrive,” on page 162 for more information.

Note: If the USB enabled option is set to YES but an IQdrive is not inserted into the IQdrive slot on your cyclor, your treatment data will be saved only to your cyclor and not the IQdrive.

Note: If you are using the IQdrive to program your treatment, you do not need to enter your therapy information. Turn to page 70 to enter your patient, options, and hardware settings.

Select Therapy Tab

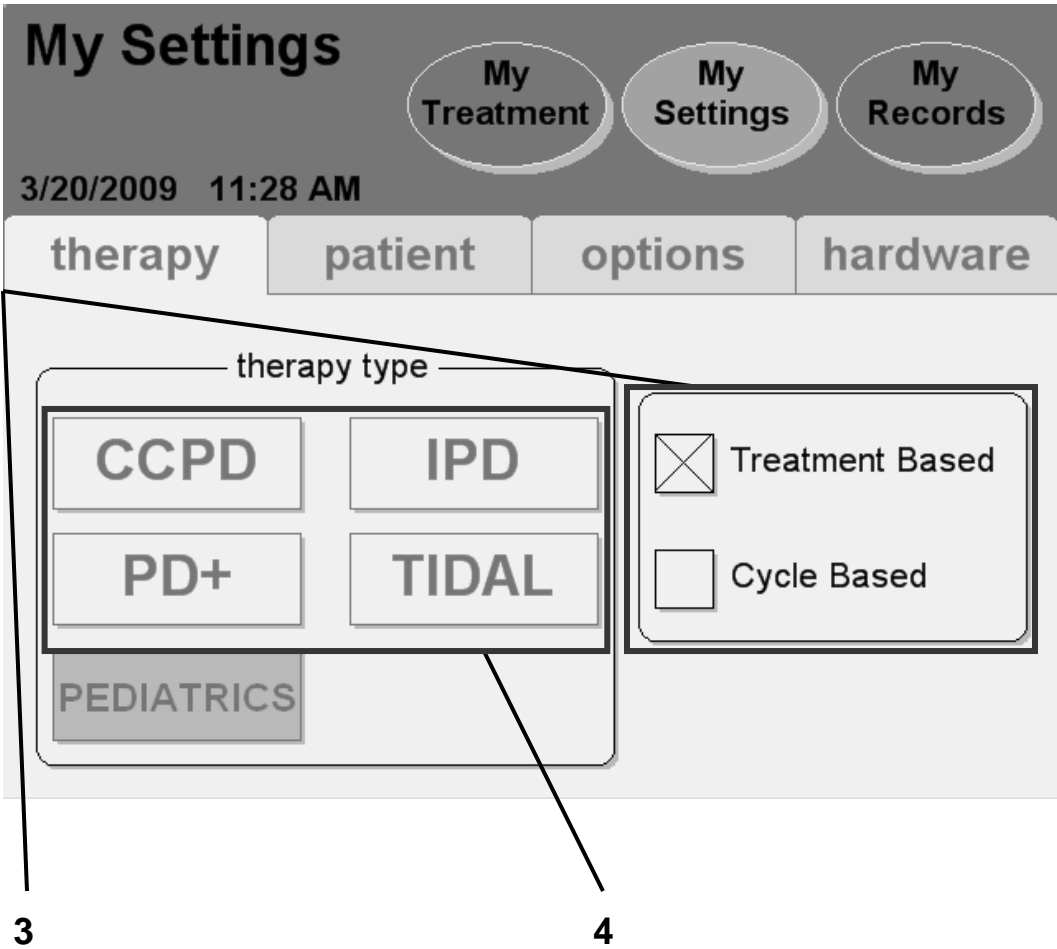

3 Select program mode

The “My Settings” screen displays your available therapy options.

Touch the program mode your prescription is based upon: Cycle based or Treatment based. A large ‘X’ will indicate the selected program mode.

Treatment Based means that you set your total treatment time. Your cycler will deliver your treatment in the specified amount of time. This mode is useful for people that need to finish treatment by a certain time in order to meet other obligations such as going to work.

Cycle Based means that your cycler will always dwell for the amount of time you set. This is used to make sure you receive the specific amount of dwell time to allow adequate removal of filter waste products and excess fluid. Your total treatment time may vary depending on how you drain and fill or if you have any alarms.

Depending on your treatment results, your doctor or PD nurse may switch you from Treatment Based to Cycle Based or vice versa.

4 Select therapy type

Touch the button matching your prescribed treatment. You will then move to the corresponding screen. Turn to the corresponding page listed below:

- **CCPD: Treatment Based**—Turn to page 50
- **CCPD: Cycle Based**—Turn to page 52
- **IPD: Treatment Based**—Turn to page 54
- **IPD: Cycle Based**—Turn to page 56
- **PD+: Treatment Based**—Turn to page 58
- **PD+: Cycle Based**—Turn to page 60
- **TIDAL: Treatment Based**—Turn to page 62
- **TIDAL: Cycle Based**—Turn to page 66
- **PEDIATRICS**—Not available at this time

See page 116 for information on the different therapy types.



Warning: The values and selections shown in pictures here are for example only. You must enter the values prescribed by your doctor; see “My Treatment Parameters,” page 2.

CCPD: Treatment-Based Settings

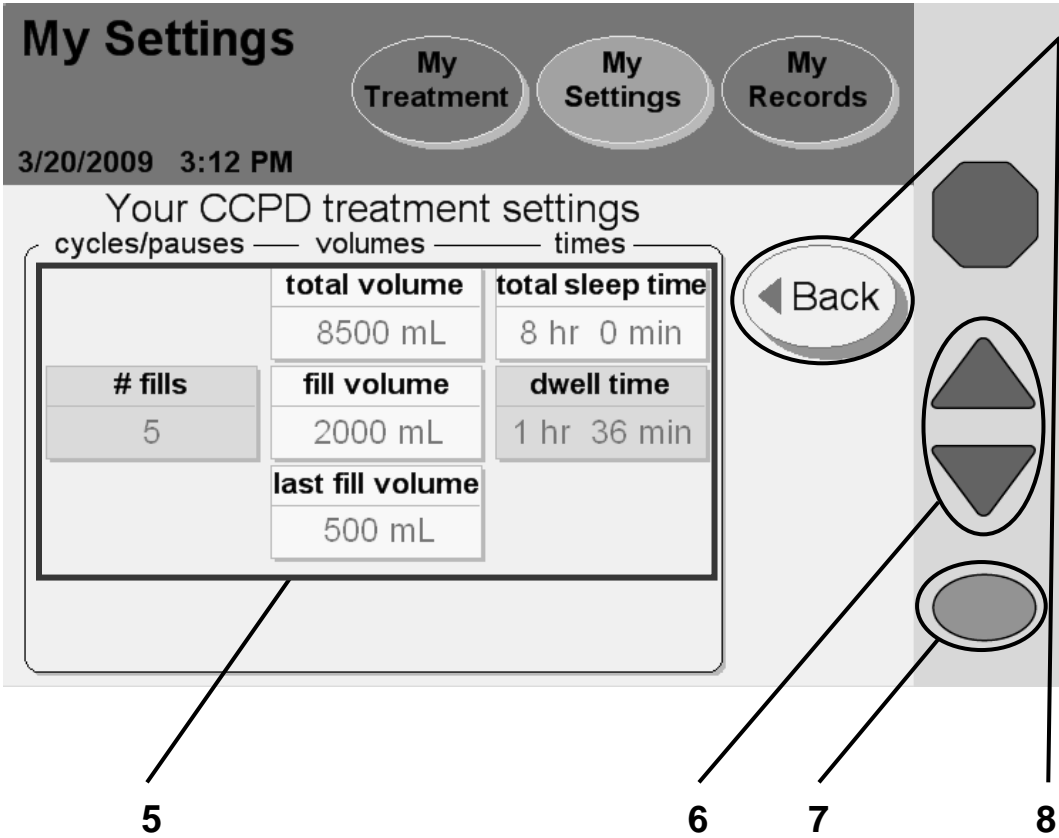

i **Note:** The values shown here are for example only. You must use the values prescribed by your doctor.



Note: If your prescription is for cycle-based therapy, this screen will display different options. Turn to page 52 for cycle-based CCPD.

5 Select values

Touch the yellow button to select the value it displays:

- **Total volume**—The amount of dialysate used for your entire treatment
- **Fill volume**—The amount of every Fill (except last)
- **Last fill volume**—The amount of your last Fill
- **Total sleep time**—Estimated sum of all Drain, Fill, and Dwell time during the treatment



Note: Light blue buttons cannot be selected. Your machine calculates the values in blue buttons based on the values you enter in the yellow buttons.

Note: If the ‘last bag option’ was set to YES, the last fill volume button will instead be last bag fill volume. If you need to set the last bag option, see “Options Settings,” on page 80.

6 Enter values

When you touch a yellow button, it will turn orange. Use the **Up/Down Arrow** (▼/▲) keys to set it to your prescribed value.

Repeat these steps to enter all of your prescribed values.

7 Press **OK**

Press the **OK** key to confirm and save your settings.

8 Touch **Back**

Touch the **Back** button to return to the “My Settings” main screen.

Skip to page 70 to enter your personal Patient Settings.

CCPD: Cycle-Based Settings

My Settings

1/24/2008 10:22 AM

Your CCPD treatment settings

# fills	fill volume	dwelt time
5	2000 mL	1 hr 30 min
		fill time
		0 hr 10 min
	last fill volume	drain time
	500 mL	0 hr 20 min
	total volume	total sleep time
	8500 mL	8 hr 30 min

5

6

7

8

i **Note:** The values shown here are for example only. You must use the values prescribed by your doctor.



Note: If your prescription is for treatment-based therapy, this screen will display different options. Turn to page 50 for treatment-based CCPD.

5 Select values

Touch the yellow button to select the value it displays:

- **# fills**—Number of Fills during treatment
- **Fill volume**—The amount of every Fill (except last)
- **Last fill volume**—The amount of your last Fill
- **Dwell time**—The amount of time the dialysate Dwells in you
- **Fill time**—The amount of time available to Fill you
- **Drain time**—The amount of time available to Drain you after a Dwell



Note: Light blue buttons cannot be selected. Your machine calculates the values in blue buttons based on the values you enter in the yellow buttons.

Note: If the ‘last bag option’ was set to YES, the **last fill volume** button will instead be **last bag fill volume**. If you need to set the last bag option, see “Options Settings,” on page 80.

6 Enter values

When you touch a yellow button, it will turn orange. Use the **Up/Down Arrow** (▼/▲) keys to set it to your prescribed value.

Repeat these steps to enter all of your prescribed values.

7 Press **OK**

Press the **OK** key to confirm and save your settings.

8 Touch **Back**

Touch the **Back** button to return to the “My Settings” main screen.

Skip to page 70 to enter your personal Patient Settings.

IPD: Treatment-Based Settings

My Settings

My Treatment My Settings My Records

1/24/2008 10:54 AM

Your IPD treatment settings

cycles/pauses — volumes — times

	total volume	total sleep time
	10000 mL	9 hr 0 min
# fills	fill volume	dwell time
5	2000 mL	1 hr 47 min
# pauses	pause volume	
1	2000 mL	

5 6 7 8

 **Note:** The values shown here are for example only. You must use the values prescribed by your doctor.



Note: If your prescription is for cycle-based therapy, this screen will display different options. Turn to page 56 for cycle-based IPD.

5 Select values

Touch the yellow button to select the value it displays:

- **# pauses**—Number of Pauses during treatment
- **Total volume**—The amount of dialysate used for your entire treatment
- **Fill volume**—The amount of every Fill
- **Pause volume**—How much you are to be Filled with each Pause
- **Total sleep time**—Estimated sum of all Drain, Fill, and Dwell time during your treatment



Note: Light blue buttons cannot be selected. Your machine calculates the values in blue buttons based on the values you enter in the yellow buttons.

Note: If the ‘last bag option’ was set to YES, the last **fill volume** button will instead be **last bag fill volume**. If you need to set the last bag option, see “Options Settings,” on page 80.

6 Enter values

When you touch a yellow button, it will turn orange. Use the **Up/Down Arrow** (▼/▲) keys to set it to your prescribed value.

Repeat these steps to enter all of your prescribed values.

7 Press

Press the **OK** key to confirm and save your settings.

8 Touch

Touch the **Back** button to return to the “My Settings” main screen.

Skip to page 70 to enter your personal Patient Settings.

IPD: Cycle-Based Settings

My Settings

My Treatment My Settings My Records

1/24/2008 11:10 AM

Your IPD treatment settings
cycles/pauses — volumes — times

# fills	fill volume	dwelt time
5	2000 mL	1 hr 30 min
# pauses	pause volume	fill time
1	2000 mL	0 hr 10 min
		drain time
		0 hr 20 min
	total volume	total sleep time
	10000 mL	8 hr 30 min

5

6

7

8

 **Note:** The values shown here are for example only. You must use the values prescribed by your doctor.



Note: If your prescription is for treatment-based therapy, this screen will display different options. Turn to page 54 for treatment-based IPD.

5 Select values

Touch the yellow button to select the value it displays:

- **# fills**—Number of Fills during treatment
- **# pauses**—Number of Pauses during treatment
- **Fill volume**—The amount of every Fill
- **Pause volume**—How much you are to be Filled with each Pause
- **Dwell time**—The amount of time the dialysate Dwells in you
- **Fill time**—The amount of time available to Fill you
- **Drain time**—The amount of time available to Drain you after a Dwell



Note: Light blue buttons cannot be selected. Your machine calculates the values in blue buttons based on the values you enter in the yellow buttons.

6 Enter values

When you touch a yellow button, it will turn orange. Use the **Up/Down Arrow** (▼/▲) keys to set it to your prescribed value.

Repeat these steps to enter all of your prescribed values.

7 Press **OK**

Press the **OK** key to confirm and save your settings.

8 Touch **Back**

Touch the **Back** button to return to the “My Settings” main screen.

Skip to page 70 to enter your personal Patient Settings.

PD+: Treatment-Based Settings

My Settings

My Treatment My Settings My Records

1/24/2008 11:21 AM

Your PD+ treatment settings

cycles/pauses — volumes — times

	total volume	total sleep time
	10500 mL	8 hr 00 min
# fills	fill volume	
6	2000 mL	
# pauses	pause volume	dwelt time
1	2000 mL	1 hr 31 min
	last fill volume	
	500 mL	

5

6

7

8

i **Note:** The values shown here are for example only. You must use the values prescribed by your doctor.



Note: If your prescription is for cycle-based therapy, this screen will display different options. Turn to page 60 for cycle-based PD+.

5 Select values

Touch the yellow button to select the value it displays:

- **# pauses**—Number of Pauses during treatment
- **Total volume**—The amount of dialysate used for your entire treatment
- **Fill volume**—The amount of every Fill (except last)
- **Pause volume**—How much you are to be Filled with each Pause
- **Last fill volume**—The amount of your last Fill
- **Total sleep time**—Estimated sum of all Drain, Fill, and Dwell time during your treatment



Note: Light blue buttons cannot be selected. Your machine calculates the values in blue buttons based on the values you enter in the yellow buttons.

Note: If the ‘last bag option’ was set to YES, the last fill volume button will instead be last bag fill volume. If you need to set the last bag option, see “Options Settings,” on page 80.

6 Enter values

When you touch a yellow button, it will turn orange. Use the **Up/Down Arrow** (▼/▲) keys to set it to your prescribed value.

Repeat these steps to enter all of your prescribed values.

7 Press **OK**

Press the **OK** key to confirm and save your settings.

8 Touch **Back**

Touch the **Back** button to return to the “My Settings” main screen.

Skip to page 70 to enter your personal Patient Settings.

PD+: Cycle-Based Settings

The screenshot shows the 'My Settings' screen for a PD+ device. At the top, there are three buttons: 'My Treatment', 'My Settings', and 'My Records'. Below these is the date and time: '1/24/2008 11:36 AM'. The main heading is 'Your PD+ treatment settings'. Below this heading is a table of settings. To the right of the table are four physical buttons: a 'Back' button, a home button (represented by an octagon), and two arrow buttons (up and down). Lines connect these buttons to numbers 5, 6, 7, and 8 respectively.

Your PD+ treatment settings		
cycles/pauses	volumes	times
# fills	fill volume	dwelt time
5	2000 mL	1 hr 30 min
# pauses	pause volume	fill time
1	2000 mL	0 hr 10 min
	last fill volume	drain time
	500 mL	0 hr 20 min
	total volume	total sleep time
	8500 mL	7 hr 0 min

5

6

7

8



Note: The values shown here are for example only. You must use the values prescribed by your doctor.



Note: If your prescription is for treatment-based therapy, this screen will display different options. Turn to page 58 for treatment-based PD+.

5 Select values

Touch the yellow button to select the value it displays:

- **# fills**—Number of Fills during treatment
- **# pauses**—Number of Pauses during treatment
- **Fill volume**—The amount of every Fill (except last)
- **Pause volume**—How much you are to be Filled with each Pause
- **Last fill volume**—The amount of your last Fill
- **Dwell time**—The amount of time the dialysate Dwells in you
- **Fill time**—The amount of time available to Fill you
- **Drain time**—The amount of time available to Drain you after a Dwell



Note: Light blue buttons cannot be selected. Your machine calculates the values in blue buttons based on the values you enter in the yellow buttons.

Note: If the ‘last bag option’ was set to YES, the **last fill volume** button will instead be **last bag fill volume**. If you need to set the last bag option, see “Options Settings,” on page 80.

6 Enter values

When you touch a yellow button, it will turn orange. Use the **Up/Down Arrow** (▼/▲) keys to set it to your prescribed value.

Repeat these steps to enter all of your prescribed values.

7 Press **OK**

Press the **OK** key to confirm and save your settings.

8 Touch **Back**

Touch the **Back** button to return to the “My Settings” main screen.

Skip to page 70 to enter your personal Patient Settings.

Tidal: Treatment-Based Settings

My Settings

My Treatment My Settings My Records

1/24/2008 11:47 AM

Your Tidal treatment settings

cycles/pauses	volumes	times
	total volume 10500 mL	total sleep time 9 hr 00 min
# pauses 1	pause volume 2000 mL	
	first fill volume 2000 mL	
# fills 6	tidal fill volume 1500 mL	dwel time 1 hr 44 min

◀ Back

Next ▶

5 6 7 8

i **Note:** The values shown here are for example only. You must use the values prescribed by your doctor.



Note: If your prescription is for cycle-based therapy, this screen will display different options. Turn to page 66 for cycle-based TIDAL.

5 Select values

Touch the yellow button to select the value it displays:

- **# pauses**—Number of Pauses during treatment
- **Total volume**—The amount of dialysate used for your entire treatment
- **Pause volume**—How much you are to be Filled with each Pause
- **First fill volume**—The amount of your first Fill
- **Tidal fill volume**—How much you are to be Filled each exchange
- **Total sleep time**—Estimated sum of all Drain, Fill, and Dwell time during your treatment



Note: Light blue buttons cannot be selected. Your machine calculates the values in blue buttons based on the values you enter in the yellow buttons.

6 Enter values

When you touch a yellow button, it will turn orange. Use the **Up/Down Arrow** (▼/▲) keys to set it to your prescribed value.

Repeat these steps to enter all of your prescribed values.

7 Press

Press the **OK** key to confirm and save your settings.

8 Touch

Touch the **Next** button to continue to the next screen.

Tidal: Treatment-Based Settings continued

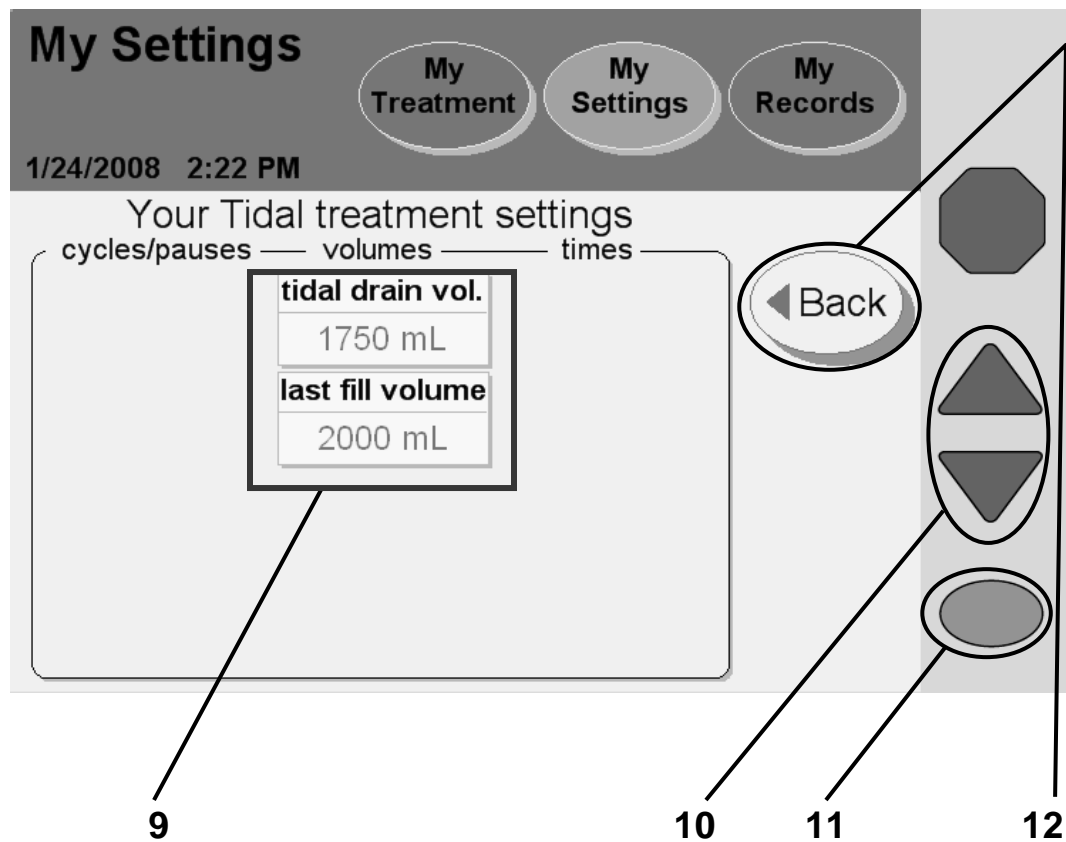

Note: The values shown here are for example only. You must use the values prescribed by your doctor.

9 Select values

Touch the yellow button to select the value it displays:

- **Tidal drain volume**—How much you are to be drained each exchange
- **Last fill volume**—The amount of your last Fill



Warning: Your Tidal Drain Volume must include your Tidal Fill Volume plus your expected UF from the Tidal Dwell in order to prevent an overflow situation. Overflowing can cause serious injury or death.



Note: Light blue buttons cannot be selected. Your machine calculates the values in blue buttons based on the values you enter in the yellow buttons.

Note: If the ‘last bag option’ was set to YES, the **last fill volume** button will instead be **last bag fill volume**. If you need to set the last bag option, see “Options Settings,” on page 80.

10 Enter values

When you touch a yellow button, it will turn orange. Use the **Up/Down Arrow** (▼/▲) keys to set it to your prescribed value.

Repeat these steps to enter all of your prescribed values.

11 Press **OK**

Press the **OK** key to confirm and save your settings.

12 Touch **Back**

Touch the **Back** button to return to the previous screen, then touch **Back** again to reach the “My Settings” main screen.

Skip to page 70 to enter your personal Patient Settings.

Tidal: Cycle-Based Settings

My Settings

My Treatment My Settings My Records

1/24/2008 3:09 PM

Your Tidal treatment settings

cycles/pauses — volumes — times

# pauses	pause volume	dwel time
1	2000 mL	1 hr 30 min
	first fill volume	fill time
	2000 mL	0 hr 10 min
# fills	tidal fill volume	drain time
6	1500 mL	0 hr 20 min
	total volume	total sleep time
	10500 mL	9 hr 00 min

5

6

7

8

Back

Next



Note: The values shown here are for example only. You must use the values prescribed by your doctor.



Note: If your prescription is for treatment-based therapy, this screen will display different options. Turn to page 62 for treatment-based Tidal.

5 Select values

Touch the yellow button to select the value it displays:

- **# pauses**—Number of Pauses during treatment
- **# fills**—Number of Fills during treatment
- **Pause volume**—How much you are to be Filled with each Pause
- **First fill volume**—The amount of your first Fill
- **Tidal fill volume**—How much you are to be Filled each exchange
- **Dwell time**—The amount of time the dialysate Dwells in you
- **Fill time**—The amount of time available to Fill you
- **Drain time**—The amount of time available to Drain you after a Dwell



Note: Light blue buttons cannot be selected. Your machine calculates the values in blue buttons based on the values you enter in the yellow buttons.

6 Enter values

When you touch a yellow button, it will turn orange. Use the **Up/Down Arrow** (▼/▲) keys to set it to your prescribed value.

Repeat these steps to enter all of your prescribed values.

7 Press **OK**

Press the **OK** key to confirm and save your settings.

8 Touch **Next**

Touch the **Next** button to continue to the next screen.

Tidal: Cycle-Based Settings continued

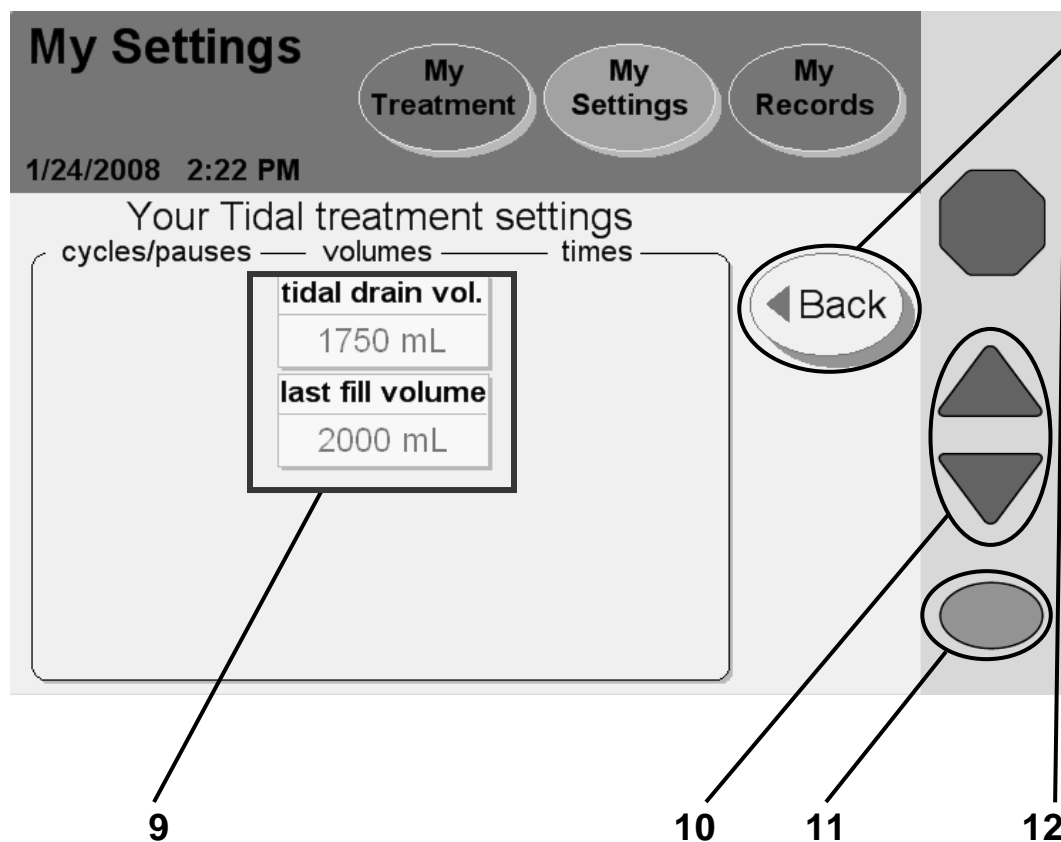

Note: The values shown here are for example only. You must use the values prescribed by your doctor.

9 Select values

Touch the yellow button to select the value it displays:

- **Tidal drain volume**—How much you are to be drained each exchange
- **Last fill volume**—The amount of your last Fill



Warning: Your Tidal Drain Volume must include your Tidal Fill Volume plus your expected UF from the Tidal Dwell in order to prevent an overflow situation. Overflowing can cause serious injury or death.



Note: Light blue buttons cannot be selected. Your machine calculates the values in blue buttons based on the values you enter in the yellow buttons.

Note: If the ‘last bag option’ was set to YES, the **last fill volume** button will instead be **last bag fill volume**. If you need to set the last bag option, see “Options Settings,” on page 80.

10 Enter values

When you touch a yellow button, it will turn orange. Use the **Up/Down Arrow** (▼/▲) keys to set it to your prescribed value.

Repeat these steps to enter all of your prescribed values.

11 Press **OK**

Press the **OK** key to confirm and save your settings.

12 Touch **Back**

Touch the **Back** button to return to the previous screen, then touch **Back** again to reach the “My Settings” main screen.

Skip to page 70 to enter your personal Patient Settings.

Patient Settings Tab

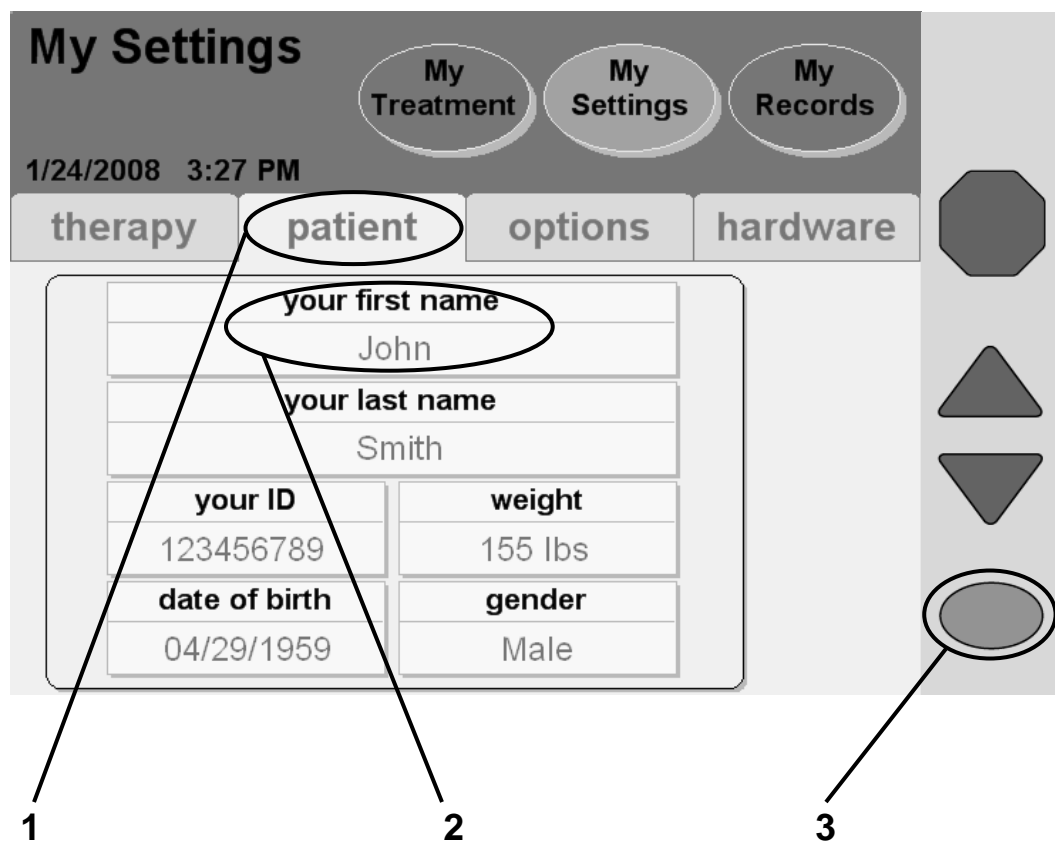

Note: The values shown here are for example only. You must use the values prescribed by your doctor.

1 Touch **patient**

Touch the **patient** button to go to the “My Settings: Your First Name” screen.

2 Touch **your first name**

3 Press **OK**

Touch the **your first name** button and then press the **OK** key to enter your first name. You will automatically move to the keyboard screen.



Note: You only need to enter your personal patient information the first time you start up your machine. Your information will be saved for later treatments.

Entering Your First Name

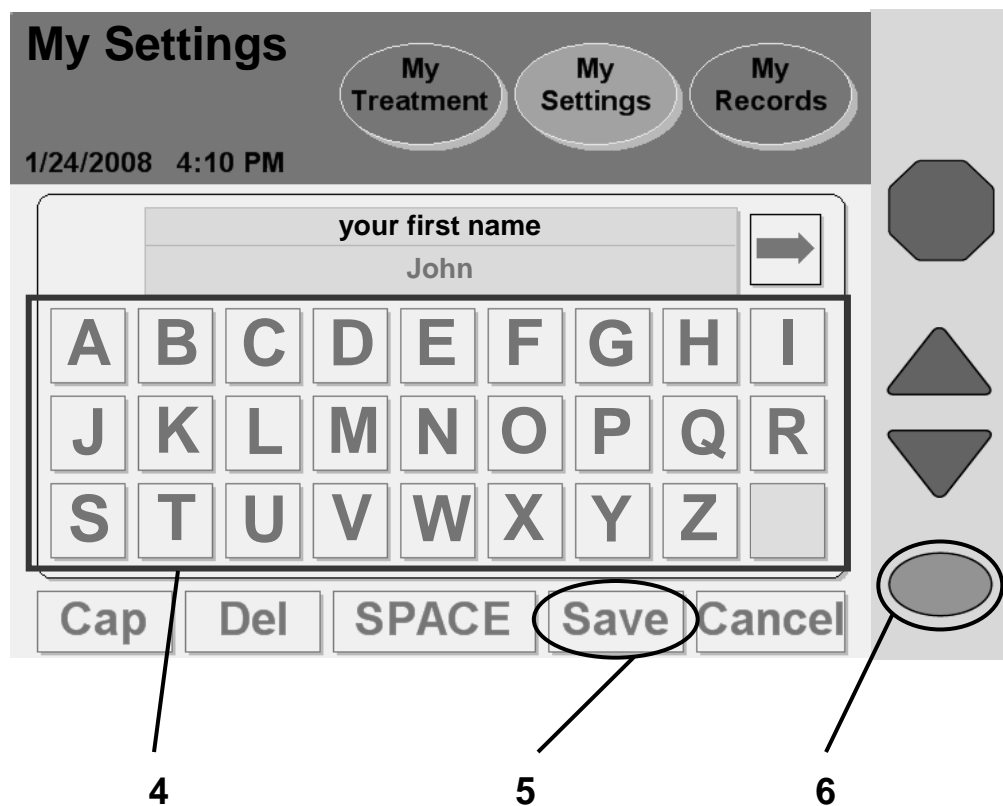

4 Enter your first name

Use the keypad displayed on the screen to enter your name by touching each corresponding letter. The name is displayed in the “Your First Name” box as you type.



Note: Delete the default name before entering your own name. To delete a letter, touch the **Del** button. To switch between upper and lowercase letters, touch the **Cap** button. To exit this screen without making any changes, touch the **Cancel** button and then press the **OK** key.

Note: If you need to enter a number or symbol, touch the ⇨ button on the right side of the text box above the keypad. To return to the letters, touch the ⇐ button that appears on the left side of the text box above the number keypad.

5 Touch **Save**

When you have entered your first name, touch the **Save** button.

6 Press **OK**

Press the **OK** key to confirm and save your settings. You will return to the “My Settings: Patient Settings” screen.

Follow the previous example and touch the **your last name** and **your ID** buttons on the “My Settings: Patient Settings” screen. Your ID number is assigned by your healthcare staff. See the “My Treatment Parameters” sheet on page 6 for your ID number.

Entering Your Date of Birth

My Settings

My Treatment My Settings My Records

1/24/2008 3:27 PM

therapy patient options hardware

your first name	
John	
your last name	
Smith	
your ID	weight
123456789	155 lbs
date of birth	gender
04/29/1959	Male

7 8 9

 **Note:** The values shown here are for example only. You must use the values prescribed by your doctor.

7 Touch **date of birth**

Touch the **date of birth** button to enter your birth date. The button will turn orange and the first set of numbers will be active.



Note: Depending on your Date Format setting, you may need to enter the day before the month; see the Date Format button in the “Hardware” section on page 82.

8 Enter your date of birth

Use the **Up/Down Arrow** (▼/▲) keys to change the first two numbers to the month of your birth date. Example:

date of birth
04/29/1959



**use arrow
keys to set**

date of birth
05/29/1959

Press the **OK** key to confirm the selection and move on to the next set of numbers in your birthdate.

date of birth
05/29/1959



**use arrow
keys to set**

date of birth
05/30/1959

Press the **OK** key to confirm the selection and move on to set your birth year as shown above.

9 Press **OK**

When you are finished entering your birth year, press the **OK** key to confirm and save your date of birth. Continue on to the next page to enter your weight.

Enter Your Weight

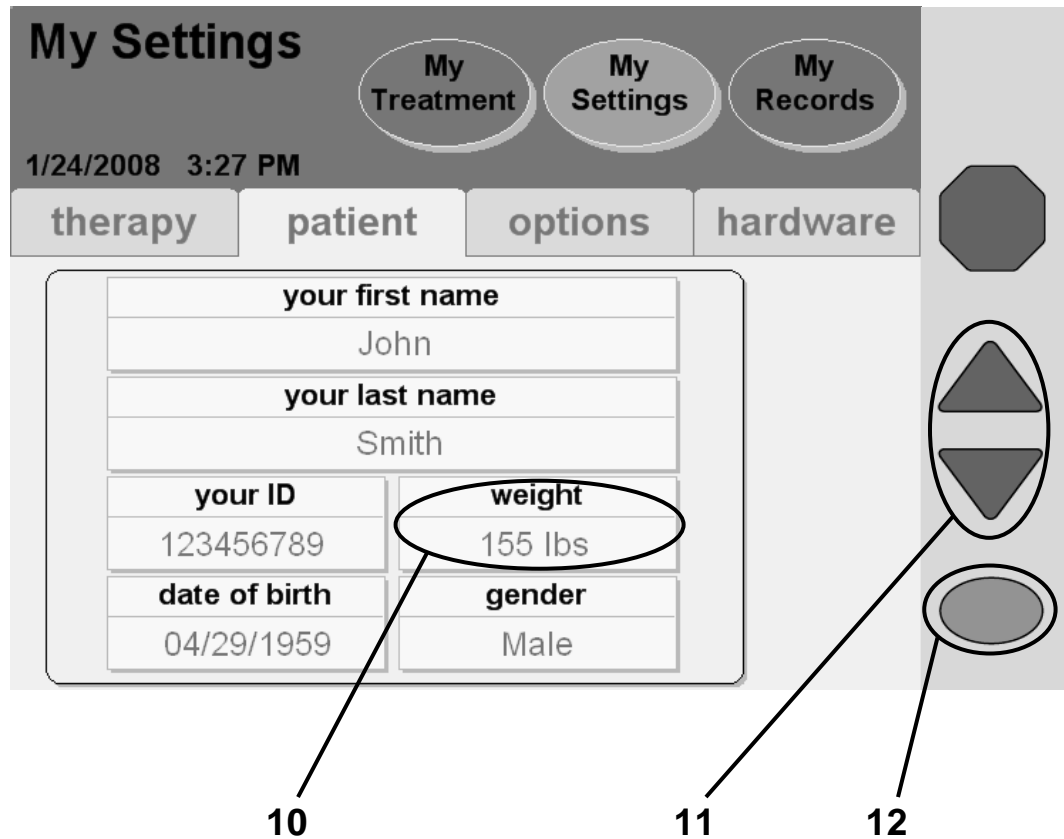

 **Note:** The values shown here are for example only. You must use the values prescribed by your doctor.

10 Touch **weight**

Touch the weight button to enter your dry weight as prescribed by your doctor.



Note: The weight entered should be your estimated dry weight or target weight as prescribed by your doctor; see “My Treatment Parameters,” page 2. Failure to enter your own prescribed treatment parameters could result in complications that may be severe.

Note: Your weight may be entered in either pounds (lbs.) or kilograms (kg). See “Options Settings,” on page 80.

11 Enter your weight

Use the **Up/Down Arrow** (▼/▲) keys to enter your weight.

12 Press **OK**

When you are finished entering your weight, press the **OK** key to confirm and save your selection. Continue on to the next page to enter your gender.

Enter Your Gender

The screenshot shows a user interface for 'My Settings'. At the top, there are three circular buttons: 'My Treatment', 'My Settings', and 'My Records'. Below these, the date and time '1/24/2008 3:27 PM' are displayed. A horizontal menu contains four tabs: 'therapy', 'patient', 'options', and 'hardware'. The 'options' tab is selected and circled. Below the tabs is a form with the following fields:

your first name	
John	
your last name	
Smith	
your ID	weight
123456789	155 lbs
date of birth	gender
04/29/1959	Male

On the right side of the screen, there is a vertical navigation bar with a stop sign icon at the top, followed by two arrow buttons (up and down) and a circular button below them. Lines connect these elements to callout numbers: 13 points to the 'gender' field, 14 points to the 'options' tab, 15 points to the circular button, and 16 points to the down arrow button.



Note: The values shown here are for example only. You must use the values prescribed by your doctor.

13 Touch gender

Touch the gender button to enter your sex.

14 Enter your gender

Use the **Up/Down Arrow (▼/▲)** keys to switch between Male and Female.

15 Press OK

When you are finished entering your gender, press the **OK** key to confirm and save your selection.

16 Touch options

Touch the **options** button to go to the “Options Settings” screen.

Options Settings Tab

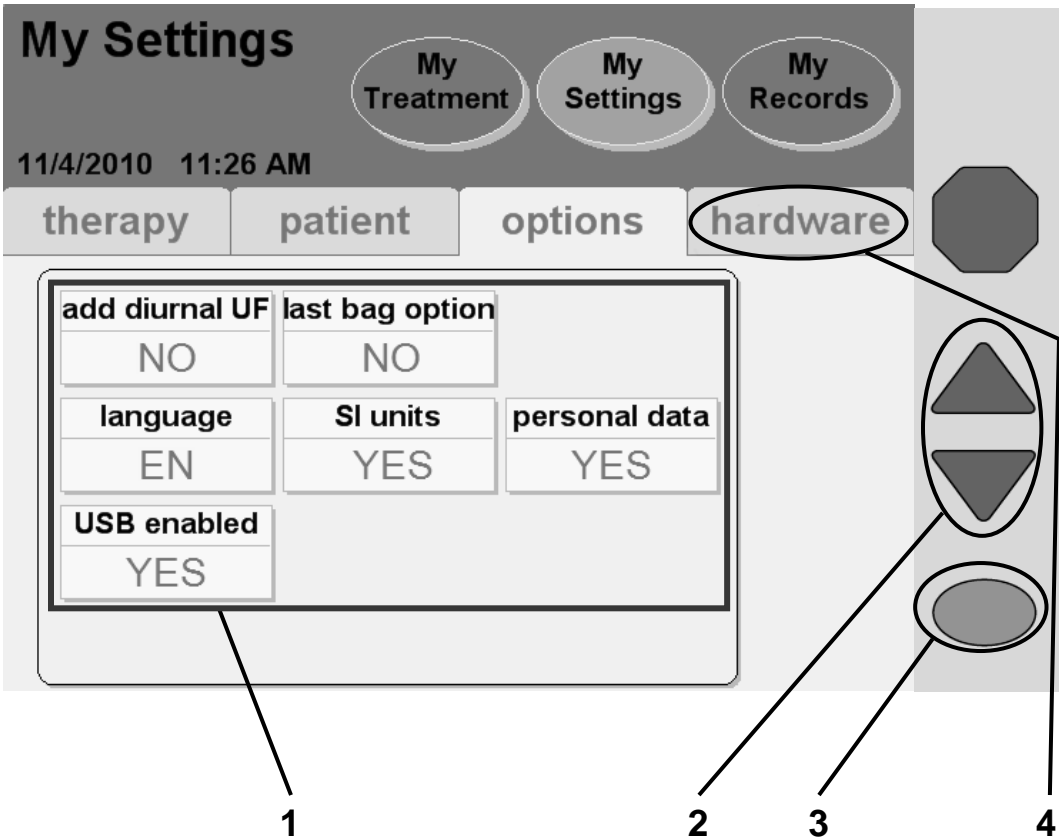

Note: The values shown here are for example only. You must use the values prescribed by your doctor.

1 Select values

Touch the yellow button to select the value it displays:

- **Add diurnal UF**—Whether or not to include Drain 0 in with the total ultrafiltration (UF) during the day. This contributes to a larger total UF volume. This option defaults to NO.
- **Language**—English, Spanish, or French.
- **Last bag option**—If this option is selected, your cyclor will fill you exclusively from the last bag (on the green clamp line) for your last Fill.
- **SI Units**—If set to NO, your weight is displayed in lbs. and your blood glucose is in mg/dL. If set to YES, your weight is in kgs and your blood glucose is in mmol/dL.
- **Personal data**—If this option is set to YES (recommended), your cyclor will ask you to enter your updated health information after each treatment is complete.
- **USB enabled**—Whether or not the IQdrive is to be used to transfer and store therapy settings and treatment data.

2 Enter values

When you touch a yellow button, it will turn orange. Use the **Up/Down Arrow** (▼/▲) keys to set it to your prescribed value. Repeat these steps to enter all of your prescribed values.

3 Press

Press the **OK** key to confirm and save your settings.

4 Touch

Touch the **hardware** button to go to the “Hardware Settings” screen.

Hardware Settings Tab

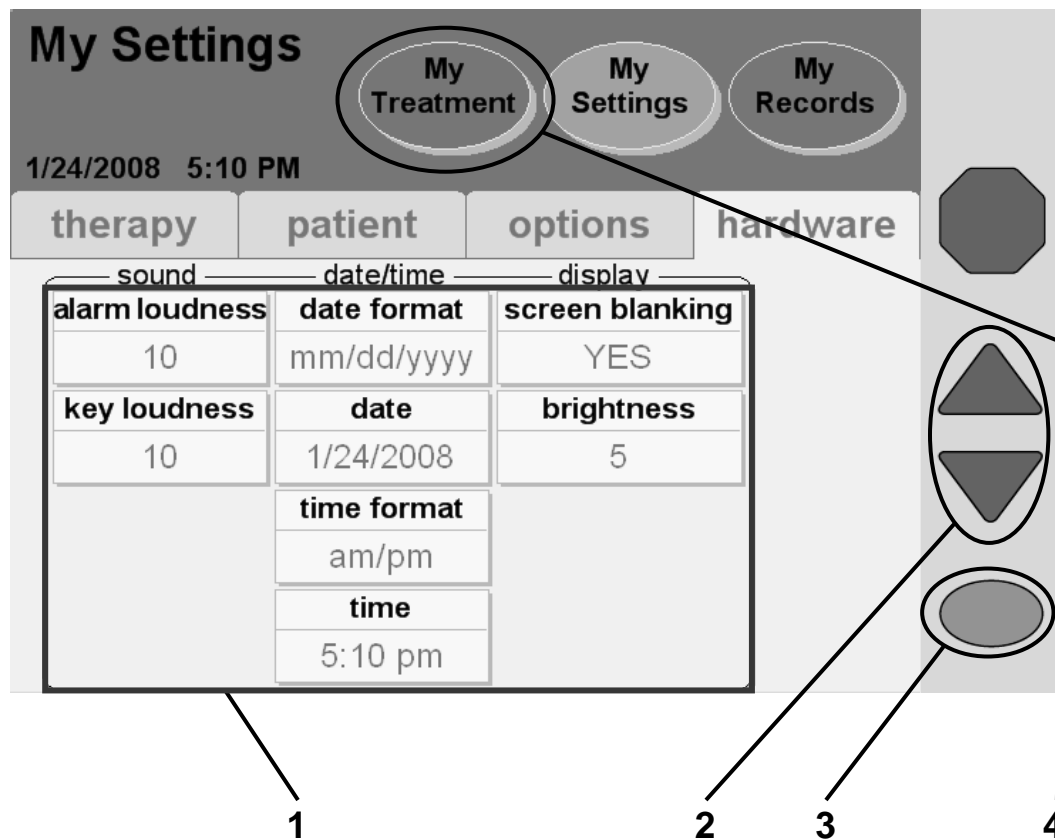

1 Select values

Touch the yellow button to select the value it displays:

- **Alarm loudness**—The volume level of the alarm (1 = soft, 20 = loud)
- **Key loudness**—How loud the key-press sound is (0 = off, 20 = loud)
- **Date Format**—Choose between listing the day before the month or the month before the day
- **Date**—Set today's calendar date (see page 75 for example)
- **Time format**—Choose between 12-hour (AM/PM) or 24-hour time
- **Time**—Set the time
- **Screen blanking**—If this option is set to YES (or ON), your Touch Screen will go dark after ten minutes of inactivity. If screen-blanking is set to NO (or OFF), your screen will always stay on.
- **Brightness**—How bright the screen is (1 = dark, 10 = bright)

2 Enter values

When you touch a yellow button, it will turn orange. Use the **Up/Down Arrow** (▼/▲) keys to set it to the desired value. Repeat these steps to enter all of your values.

3 Press

Press the **OK** key to confirm and save your settings.

4 Touch

At this point, you should have entered your entire prescription. When you are ready to begin your treatment, touch the **My Treatment** screen-button.



Warning: Do not begin your treatment if your settings are incorrect. Improper treatment settings could result in complications that may be severe.

If you are not yet ready to start your treatment, you may leave your machine on this screen. The screen will blank-out after ten minutes if screen blanking is set to YES. Touch anywhere on the screen to restore the display, when desired.

This Page is Intentionally Blank

My Treatment

Pre-Treatment Checklist

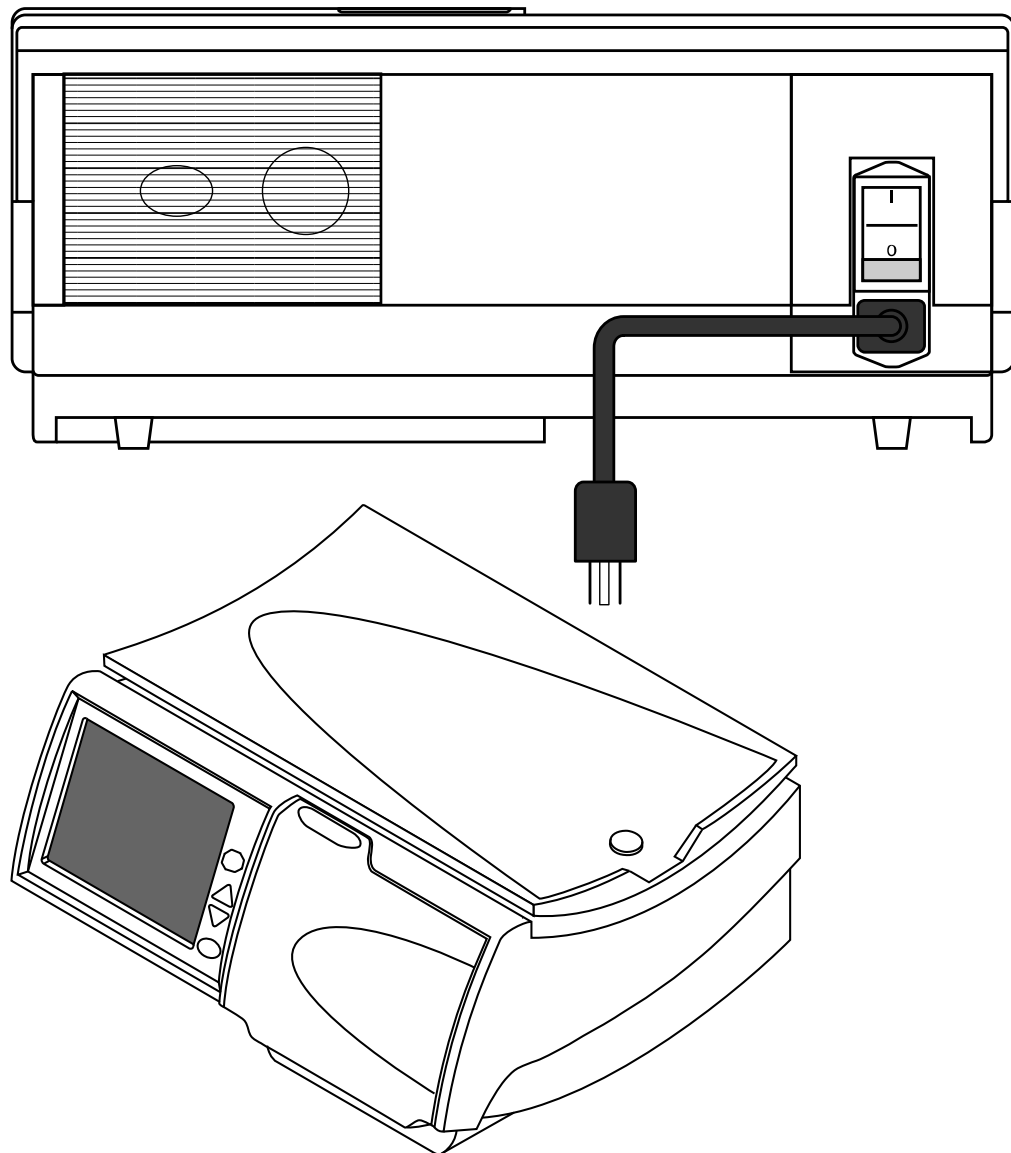

Getting Started

Before you start your treatment, you should check the following on your cyclor:

- Check that the power cord is plugged into a grounded, three-prong electrical outlet, and the power switch on the back of your machine is in the **ON** (|) position.
- Check that the heater tray is free from obstructions and is not touching the top of your cyclor's cabinet (as described on page 41).
- Check that your machine has been recently cleaned and is ready for treatment (see page 202 for more information).

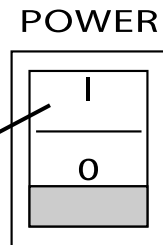

Warning: If any of the conditions listed above have not been met, you must correct them before continuing with your treatment preparation. Failure to do so could result in complications that may be severe.



Note: Check that, if you are using an IQdrive, the IQdrive is inserted properly into the IQdrive slot on the back of your machine (see page 162).

Note: Your Liberty cyclor automatically runs a self test during startup and alerts you if a problem exists. No manual testing of your cyclor is required after installation.

Starting Your Treatment

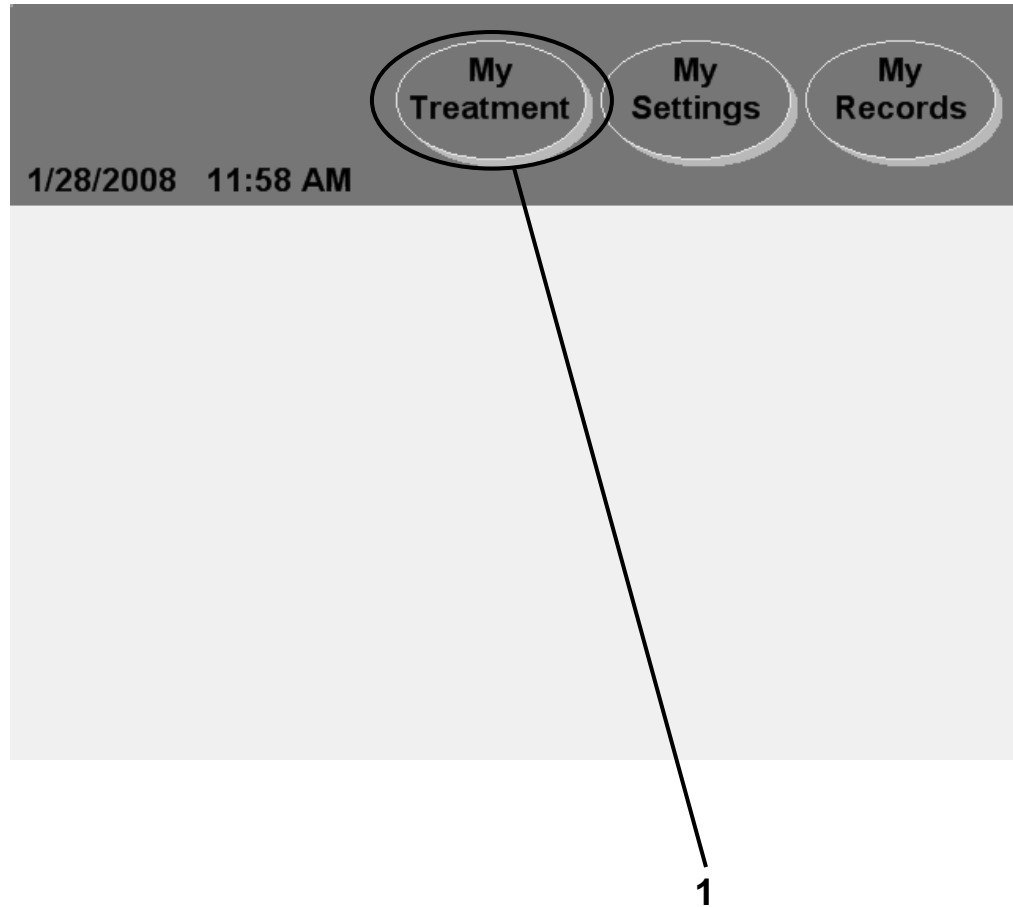

1 Touch **My Treatment**

You may reach the “Treatment” screens from any other screen. Touch the **My Treatment** screen-button to begin your treatment setup procedures.

If your cyclor is ON but the screen has blanked-out and is dark, you may touch anywhere on the Touch Screen to restore the display.



Warning: Do not begin your treatment until your entire prescription has been entered.

Warning: Check for proper functioning of your machine before beginning your treatment.



Note: This manual is only a guide for the Liberty cyclor screens. Follow your exact screen order on the machine and use these pictures only as a reference.

Note: If your IQdrive therapy settings have changed since your last treatment, you will need to review those settings before continuing with your treatment. See “Using the IQdrive,” on page 162. *Do not remove the IQdrive during your treatment.*

Starting Treatment continued

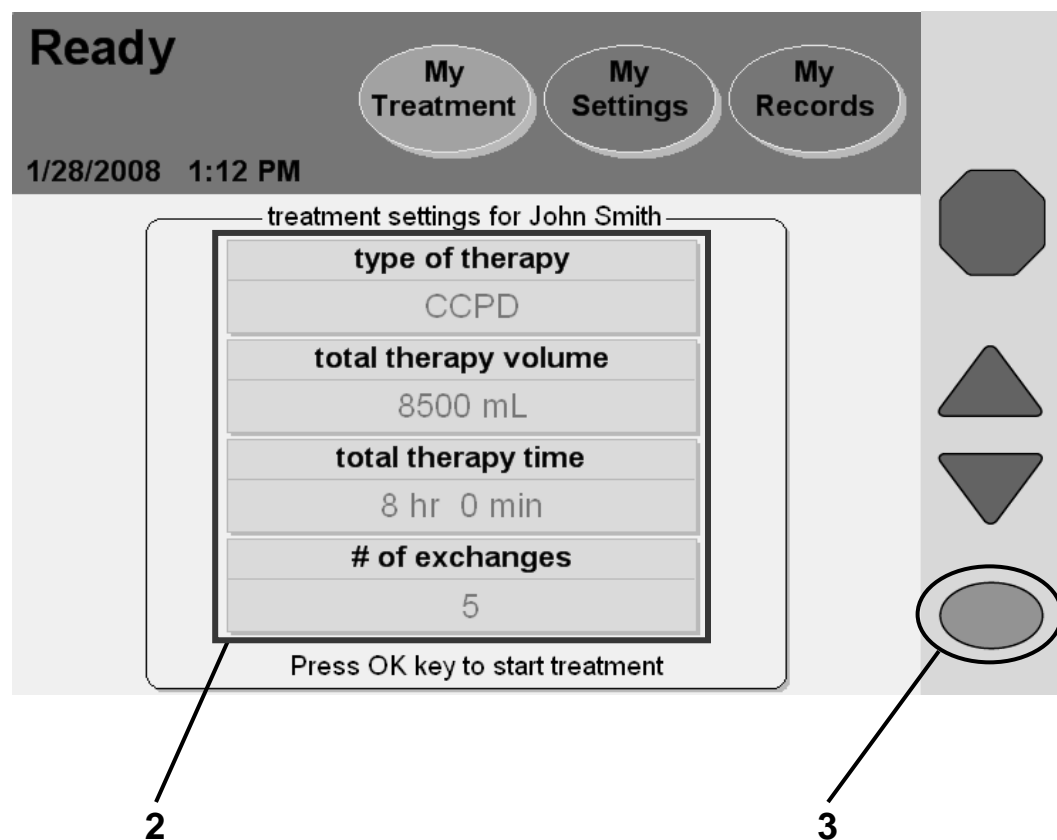

Note: The values shown here are for example only. You must use the values prescribed by your doctor.

2 Verify treatment values

The treatment parameters displayed here must match your prescription (see page 2). If you still need to enter the correct values, turn to page 46.

3 Press

If the treatment values are listed correctly, press the **OK** key to continue. Your cyclor will take a moment to process and you will move on to the next screen.



Warning: Your doctor must prescribe your entire treatment. Using incorrect values could result in complications that may be severe. Do not use example values shown in machine pictures.

Preparing

Set-Up

3/18/2009 9:21 AM

My Treatment My Settings My Records

step 1

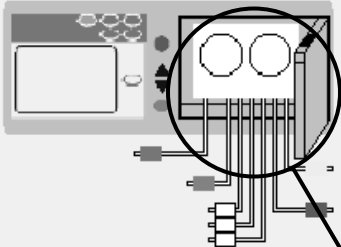

Gather supplies,
mask, and wash
hands.

Insert
cassette

4 Gather Supplies

5

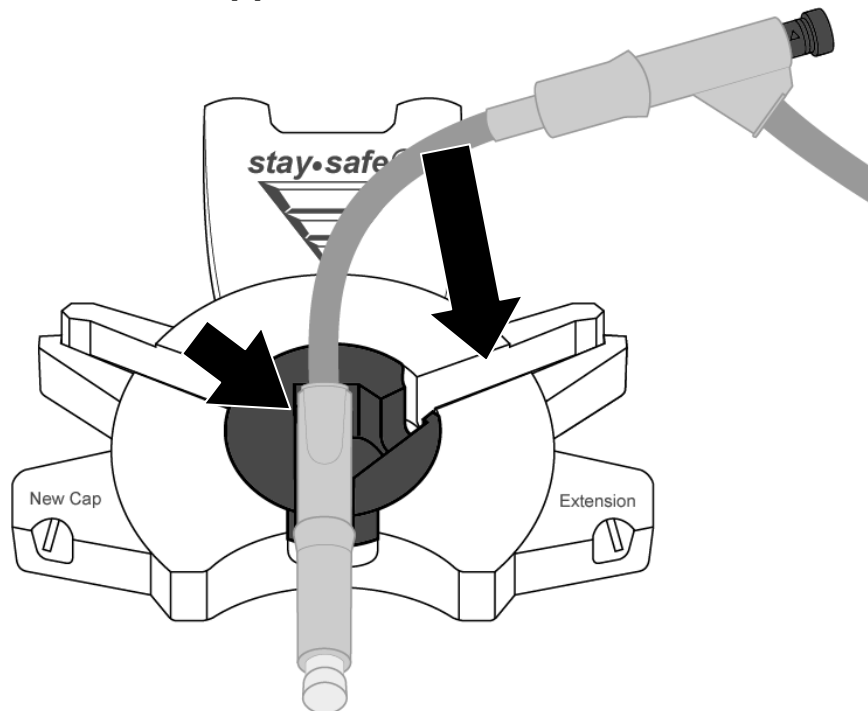

4 Gather supplies, mask, and wash hands

Before starting your treatment, you will need to get the following ready:

- **Supplies**—Typical supplies are:
 - ✓ Solution bags
 - ✓ Cassette and extension set
 - ✓ stay•safe caps
 - ✓ Drain line or drain bags
 - ✓ Hand sanitizer
- **Mask**—Put on your mask, everyone else in the room must also wear a mask
- **Wash hands**—Wash your hands as instructed by your healthcare staff



Warning: You must use aseptic technique as directed by your PD nurse to prevent infection.

5 Insert cassette



Warning: Check that the pump module is clean and free from obstructions before inserting the cassette. Keep fingers clear of moving parts.

Warning: A new, sterile cassette and drain line must be used for every treatment. Check that the cassette and tubing are free from kinks or damage. Damaged tubing or cassettes can lead to leaks, contamination, and infection.



Caution: The cassette door is pressurized. Do not attempt to reopen the cassette door until your machine instructs you to. Do not touch the door sensor when loading the cassette, see page 32.

To insert the cassette:

- Firmly push the door latch to open the cassette door.
- Hold the cassette with the plastic domes facing outward.
- Slide the cassette up against the guide pins at the top of the pump module. Then snap the cassette in place using the catch at the bottom of the pump module. See “The Pump Module” on page 32 for a drawing of the pump plate. The tubing lines from the cassette must be hanging down in the front and free from kinks.
- Close the door over the cassette, making sure the door clicks into place to lock it. Your cyclor will pressurize the cassette door and then display the next setup screen.

Next insert your stay•safe connector into the stay•safe organizer clip below the control panel. Insert the tubing into the Tubing Channel on the right.

Connect Solution Lines

Set-Up

My Treatment My Settings My Records

3/18/2009 9:26 AM

step 2

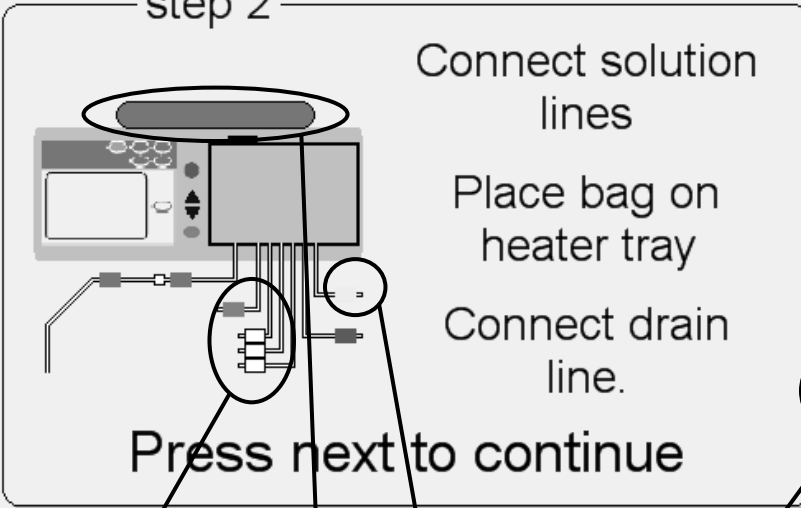

Connect solution lines

Place bag on heater tray

Connect drain line.

Press next to continue

Next ▶

6 7 8 9

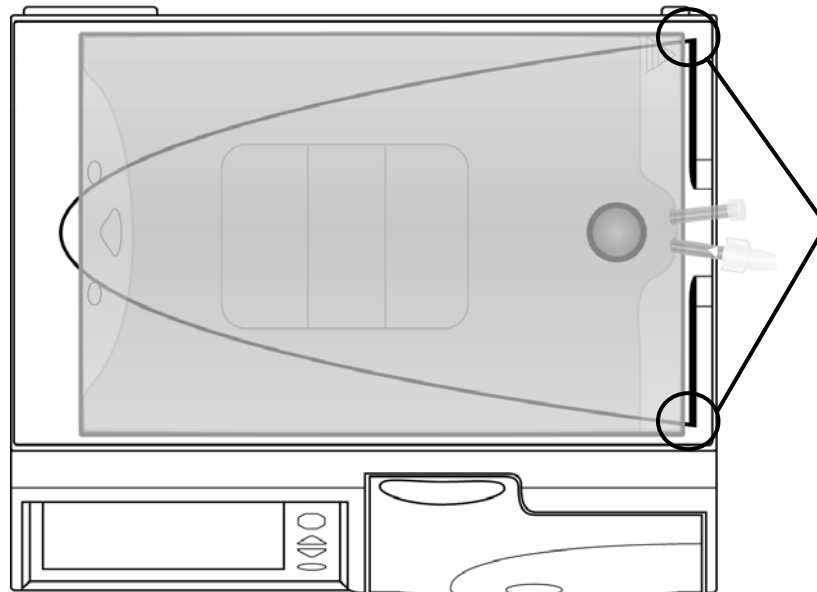

Heater Bag Placement

Line up solution bag at corners.
Do not extend bag over edge

6 Connect solution lines

Place your solution bags on a flat surface with the connection ports facing you. Connect the white clamp lines to the solution bags. Connect the green clamp line to the last bag of your treatment, if prescribed.



Caution: If you are using the Liberty cart, be sure to properly balance the solution bags by hanging them on both sides of the cart. Unbalanced bags on the cart may cause it to tip over and damage your machine.

7 Place bag on heater tray

Place a solution bag that is at least 2000 mL on the heater tray. Connect it to the red clamp heater line.



Warning: You must properly connect your solution bags as prescribed.

Warning: Do not use external heating sources not authorized by Fresenius Medical Care to warm your solution bags. Contact your healthcare staff for more information.

Warning: Make sure that the solution lines are free from kinks.

Warning: Do not allow the heater bag to hang off the heater tray and touch the cabinet.



Note: The bag you use for your heater bag must be at least 1000 mL larger than your first Fill volume.

8 Connect drain lines

Connect the cassette's yellow clamp line to a drain line or drain bag set. Do not close the yellow clamp.



Note: If you connect directly to a drain line instead of a drain bag set, an air gap at the end of the line must be present to allow proper drainage. The end of the drain line must not be submerged in liquid such as a tub or toilet bowl.

9 Touch **Next**

All the prescribed lines should be connected at this point. Touch the **Next** button to continue; your cyclor will now weigh your heater bag.



Warning: Do not disturb the bag as it is being weighed.

Break Cones and Clamp Unused Lines

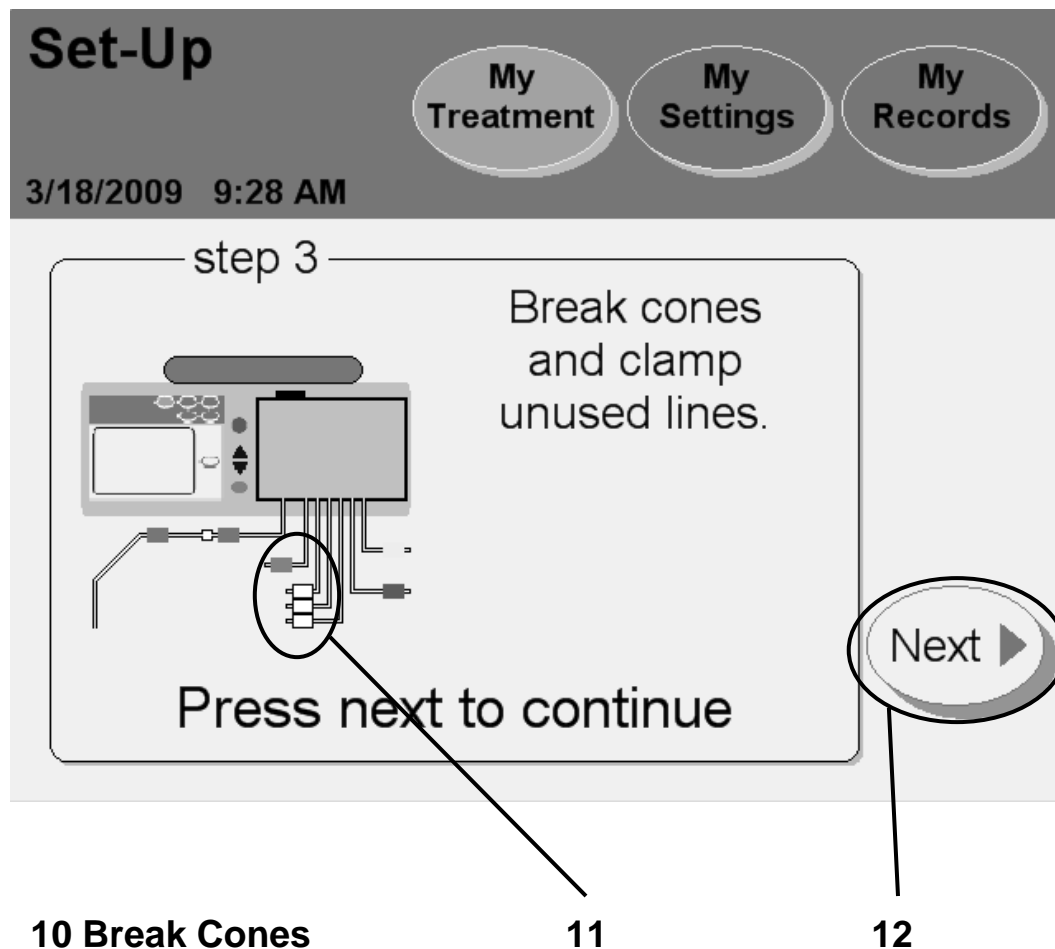

10 Break cones

Break the cones at the end of the bags by bending the ports back and forth. Make sure the cones are broken completely. After the cones are broken, nudge the cone into the solution bag if possible. You may be able to see the clear cones floating up into the bags, this is normal. The cones cannot go through the tubing and enter your body.

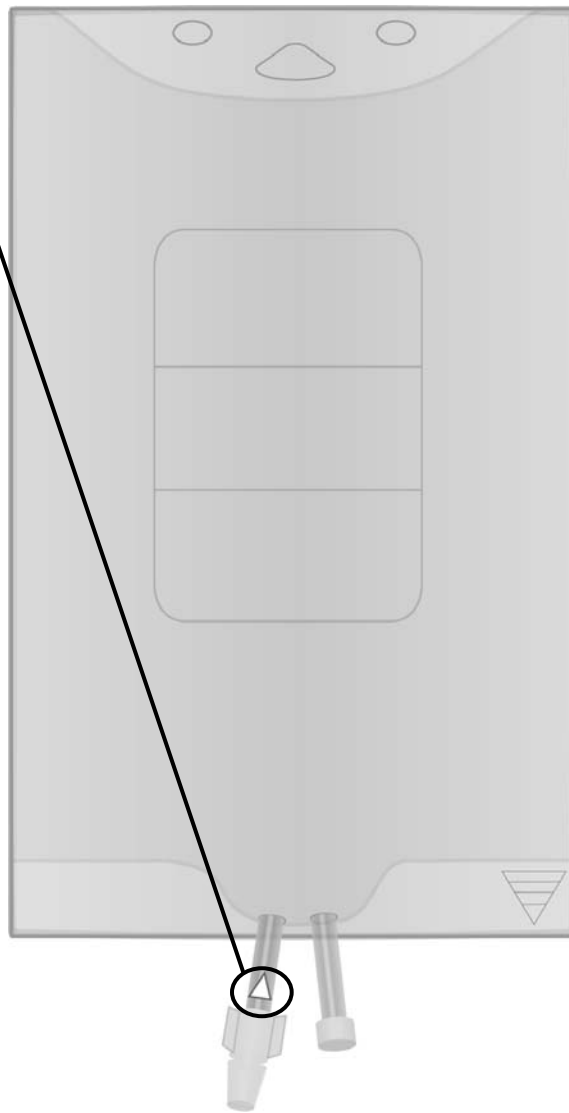

11 Clamp unused lines

Clamp any line that is not connected to a bag.

12 Touch **Next**

Touch the **Next** button to continue. Your cyclor will now test to see which lines are connected.

Check Bags





Set-Up

My Treatment My Settings My Records

3/18/2009 9:32 AM

step 4

Verify bag connections.
Press back to repeat bag detection test.

Last Bag	Bag 3	Bag 2	Bag 1	Heater Bag
				

Press next to continue

Back

Next

13

14

13 Verify bag connections

During the bag detection test, your machine automatically detects which lines are connected to solution bags. After the test, your cyclor displays which lines are connected and which are unconnected.



Unconnected



Connected

Make sure that your cyclor has properly detected the bag connections. If the test results are wrong, check the connections and clamps. Touch the **Back** button to run the test again.



Note: You must have all of your solution bags connected at this point. After the bag connection verification, you cannot connect another solution bag for your treatment.

14 Touch **Next**

When each of the connected bags is correctly displayed, touch the **Next** button. Your machine will begin flushing the lines.

Performing Flush

Flushing

3/18/2009 9:35 AM

My Treatment My Settings My Records

Time remaining
1 min 30 sec

Time set
2 min 0 sec

Please wait



Machine Flushing

Your machine will now begin a tubing flush. The screen displays a timer to count down the flushing time.

The next screen will appear when the flushing is complete.



Note: If you need to stop the flushing process, press the **STOP** key. The pump will stop and the “Flushing Stopped” screen will be displayed. Flushing will resume when you press the **OK** key.

Priming

Priming

My Treatment My Settings My Records

3/18/2009 9:50 AM

step 5

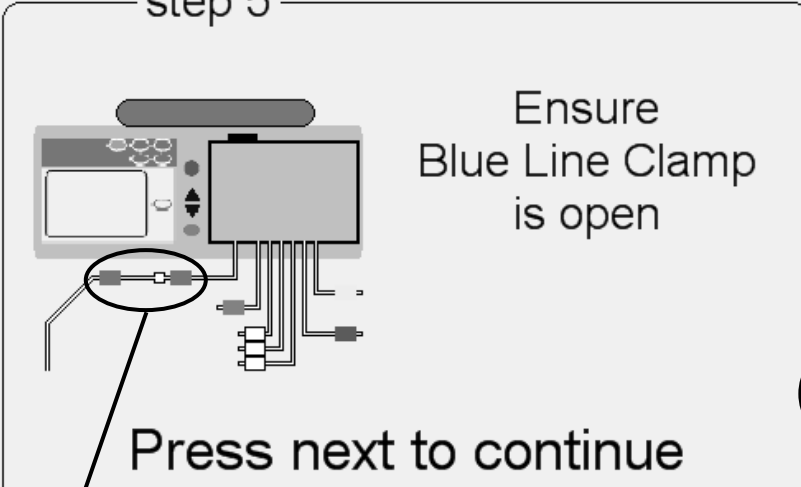

Ensure Blue Line Clamp is open

Press next to continue

Next ▶

15

16

The diagram shows a Liberty Cycler machine with several tubes connected to its back. A red circle highlights a blue line clamp on one of the tubes. A line connects this circle to the number 15. Another red circle highlights a 'Next' button with a right-pointing arrow. A line connects this circle to the number 16.

15 Ensure Blue Patient Line Clamp is open

Make sure the blue patient line clamp is open to prepare the blue patient line for priming.

16 Touch **Next**

Touch the **Next** button to begin the priming process.



Note: During the prime phase, the blue patient line must be lower than the heater bag.

Performing Prime

Priming

3/18/2009 9:53 AM

My Treatment My Settings My Records

Time remaining
0 min 15 sec

Time set
2 min 0 sec

Please wait



Performing Prime

Your machine will now prime the lines. The screen displays a timer to count down the Priming time.

The next screen will appear when the priming is complete.

Priming Complete

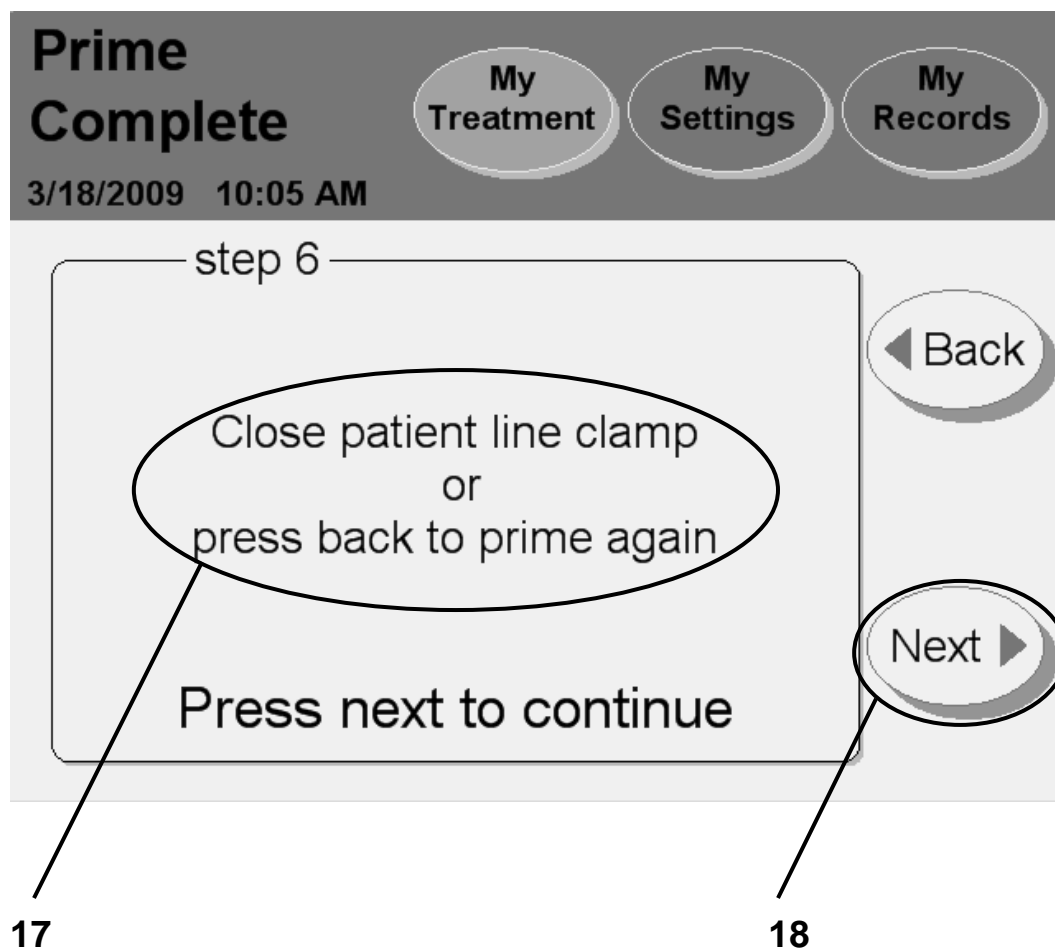

17 Close patient line clamp or press back to prime again

If you see air in the lines and need to prime them again, touch the **Back** button. Your machine will re-prime the lines.



Note: If you are using tubing set model P/N 050-87216 with a twenty foot long patient line, you must press the **Back** button again to ensure the line is fully primed.

If your lines have been primed and there is no air in them, close the blue patient line clamp.

18 Touch **Next**

Make sure your blue patient line is clamped then touch the **Next** button to continue to the next screen. There you will enter your daytime manual exchange volume, if any. A manual exchange is when you connect your catheter to a bag of solution and perform a Fill without using your Liberty cyclor.

Entering a Daytime Exchange

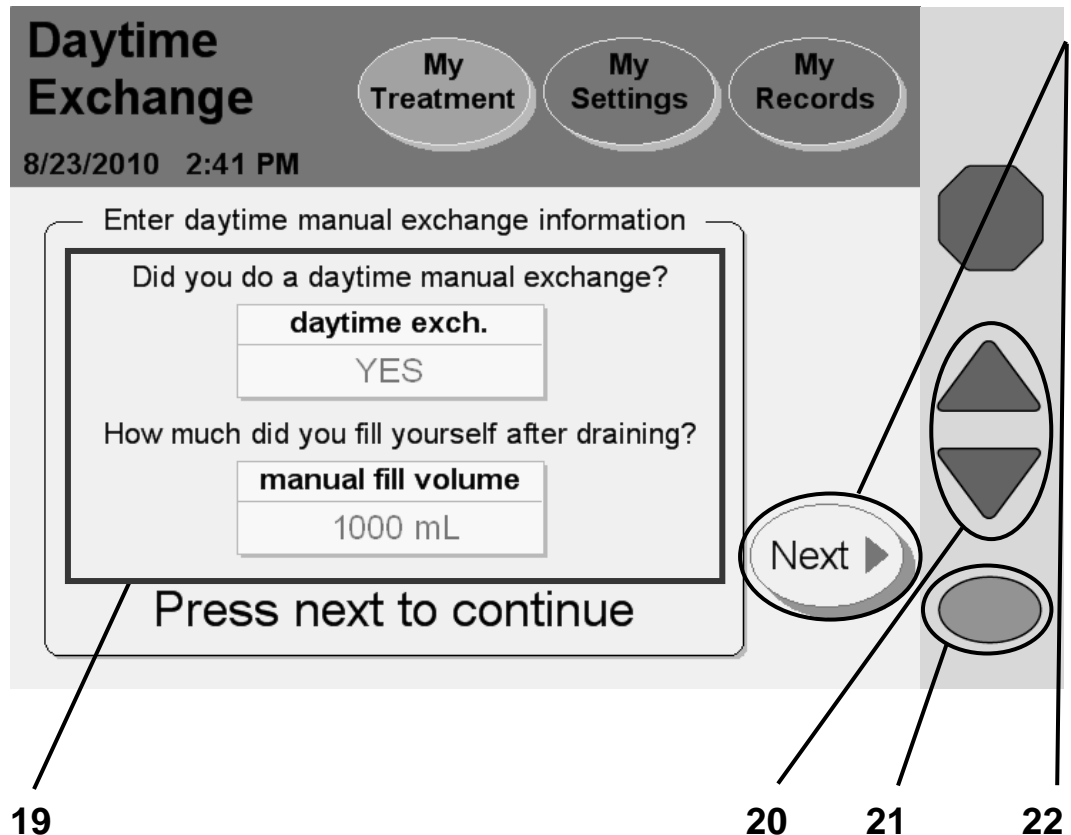

 **Note:** The values shown here are for example only. You must use the values prescribed by your doctor.

19 Select daytime manual exchange information

If you did not perform a manual exchange Fill since you last turned off your cyclor, you may leave this button set to NO. Continue to step 22 below.

If you did perform a manual exchange Fill since you last turned off your cyclor, you must set the **daytime exch.** button to YES.



Warning: You must enter whether or not you performed any manual exchanges since you last turned off your cyclor. If you performed a manual exchange, you must then also enter the fill volume. If you do not program this information into your Liberty cyclor at this time, your cyclor will not know that you have additional fluid in your abdomen. Do NOT bypass Drain 0. Your Liberty cyclor will switch to Fill 1 when you are finished draining.

To set the **daytime exch.** button to YES, touch the button and it will turn orange. Use the **Up/Down Arrow** (▼/▲) keys to change it from NO to YES. Press the **OK** key to save the change.

20 Enter volume if you had a manual exchange

After setting the **daytime exch.** button to YES, the **manual fill volume** button will change from gray to yellow. You may now edit that button. Touch the **manual fill volume** button, it will turn orange. Use the **Up/Down Arrow** (▼/▲) keys to scroll up or down to the fill volume you have left in your abdomen from your last manual exchange Fill.

21 Press **OK**

Press the **OK** key to confirm and save your settings.

22 Touch **Next**

Touch the **Next** button to continue to the next screen

Confirming Your Daytime Exchange

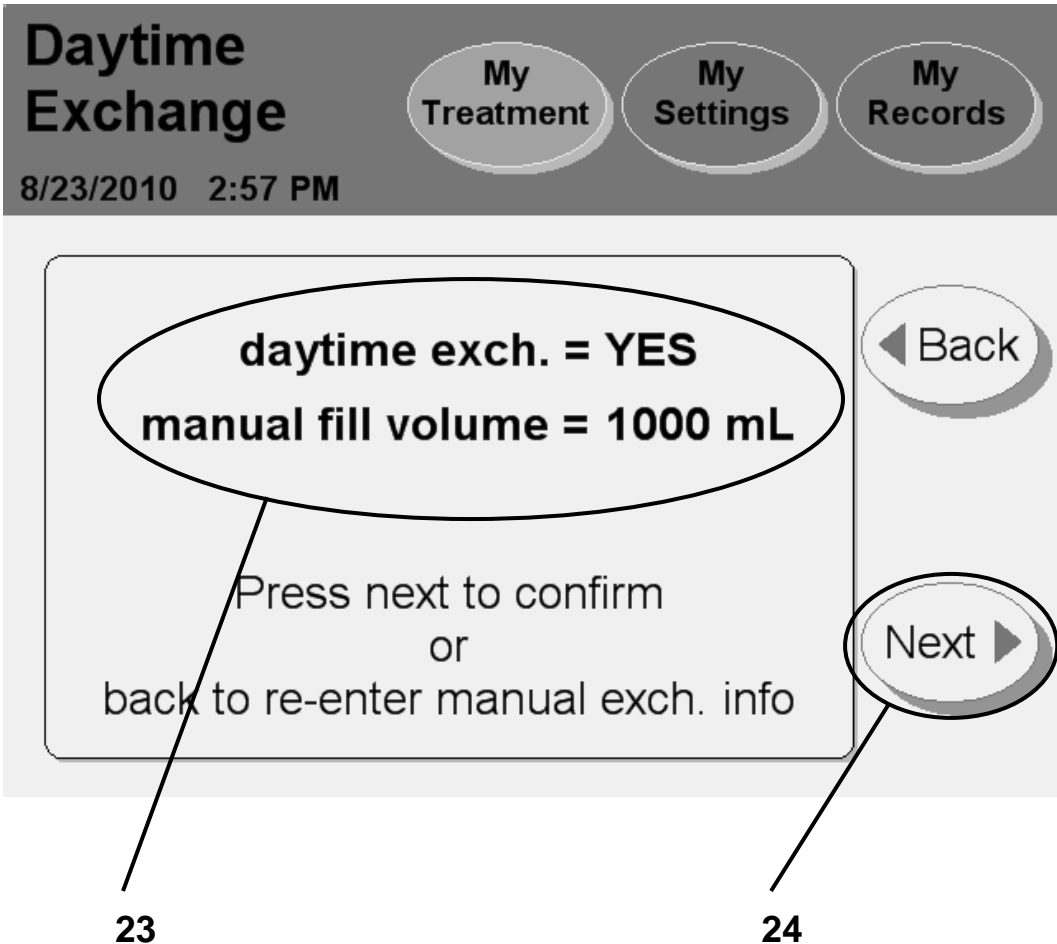

23 Double-check your settings

Your cyclor will display the daytime exchange settings you just entered on the previous screen.

If this screen does not match what you entered, touch the **Back** button. You must then re-enter the correct settings (see the previous page).

24 Touch **Next**

If your daytime exchange settings are listed correctly, touch the **Next** button to continue to the next screen. There you will see instructions on how to connect to your machine.

Connecting Yourself

Ready for Treatment

3/18/2009 10:06 AM

My Treatment My Settings My Records

step 7

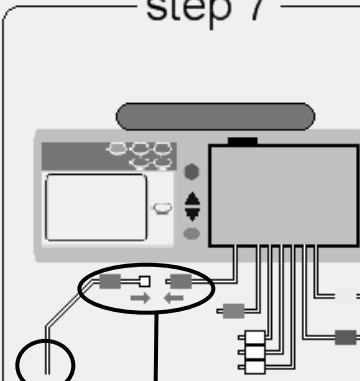

Use aseptic technique to connect blue line to yourself

Open the blue line clamp and your catheter clamp

Press next to continue

Next ▶

25

26

27

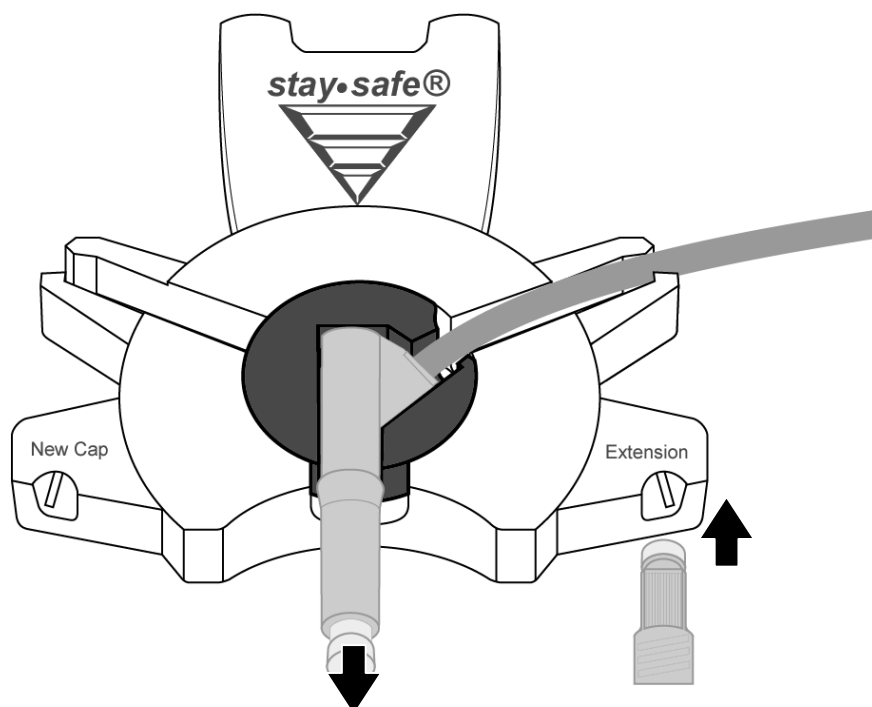

25 Use aseptic technique to connect yourself



Warning: You must use aseptic technique to prevent infection. Keep your mask on until you have finished connecting.

Warning: Use a new, sterile connector each time you connect.

To connect to your cyclor:

- Wash your hands or use hand sanitizer as directed by your PD nurse
- Insert your catheter extension cap into the Extension Cap Holder on your stay•safe system to remove the cap.
- Remove the clear stay•safe cap from the stay•safe connector
- Connect your catheter extension line to the stay•safe connector on the blue patient line

26 Open the blue patient line clamp and your catheter clamp

27 Touch **Next**

Press the **Next** button to begin your prescribed exchanges.



Warning: If you turn off your cyclor after you have filled, when you restart your cyclor you **MUST NOT** bypass Drain 0. It could result in an overflow.

Warning: If you do one or more manual daytime exchanges that are not programmed into the Liberty cyclor, your cyclor will not know that you have additional fluid in your abdomen. Do **NOT** bypass Drain 0. Your Liberty cyclor will switch to Fill 1 when you are finished draining.



Note: Your actual treatment time begins at this point, the beginning of Drain 0.

For information on bypassing an exchange, see page 158.

This Page is Intentionally Blank

Exchanges

Exchanges

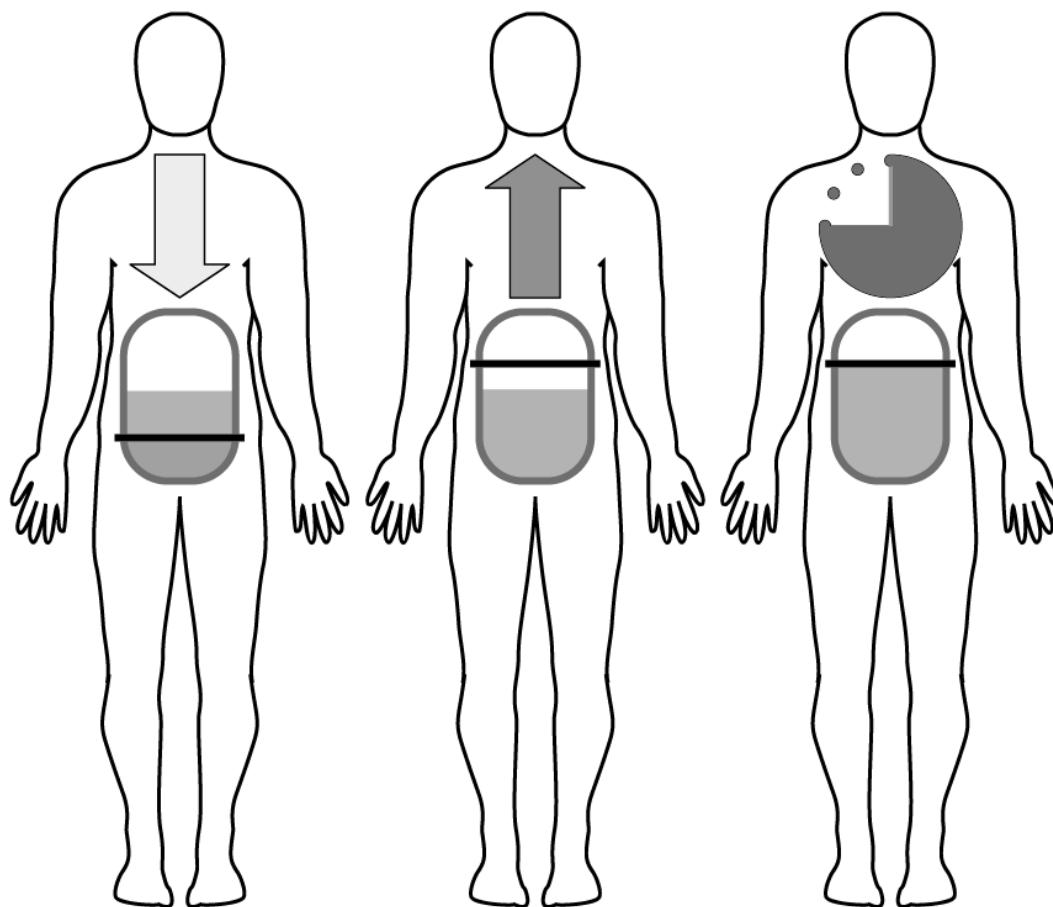

Drain

Fill

Dwell/Pause

IPD – Intermittent Peritoneal Dialysis

IPD is an *Intermittent Therapy*, meaning it is interrupted. With IPD, your cyclor does your Exchanges during the night. Your machine Drains you in the morning so you do not have dialysate in your peritoneal cavity during the day.

Tidal Peritoneal Dialysis

Depending on the program, Tidal PD can be either Intermittent or Continuous. With Tidal PD, your cyclor does your Exchanges during the night. However, your machine does not always fully drain you during each Exchange. Only a portion is Drained and Filled with each Exchange. Depending on your prescription, you may end the treatment with a Fill or Drain.

CCPD – Continuous Cycling Peritoneal Dialysis

CCPD is a *Continuous Therapy*. It is the most common therapy prescribed. With CCPD, you have dialysate in your peritoneal cavity at all times. Three or more dialysate Exchanges are done through the night and one long Exchange is done during the day. Each morning your cyclor will Fill you for the day. When you reconnect to your machine again at night, you must first drain the dialysate that Dwelled in you since the end of your last treatment.

PD+ – Peritoneal Dialysis Plus

PD Plus is a *Continuous Therapy* like CCPD, but it also includes Drains and Pause-type Dwells during the day to offer more waste removal.

Your cyclor's screen order

The number of times that you Drain, Fill, and Dwell (or Pause) depends on your prescribed therapy. The following screens are shown only to explain the different features. Follow your own machine's setup. Your cyclor will automatically take you through your prescription.

Exchange: Drain 0

Drain 1 of 2

My Treatment My Settings My Records

3/18/2009 10:10 AM

Ultrafiltration (UF)
510 mL

Expected drain volume
1000 mL

Total volume drained
1510 mL



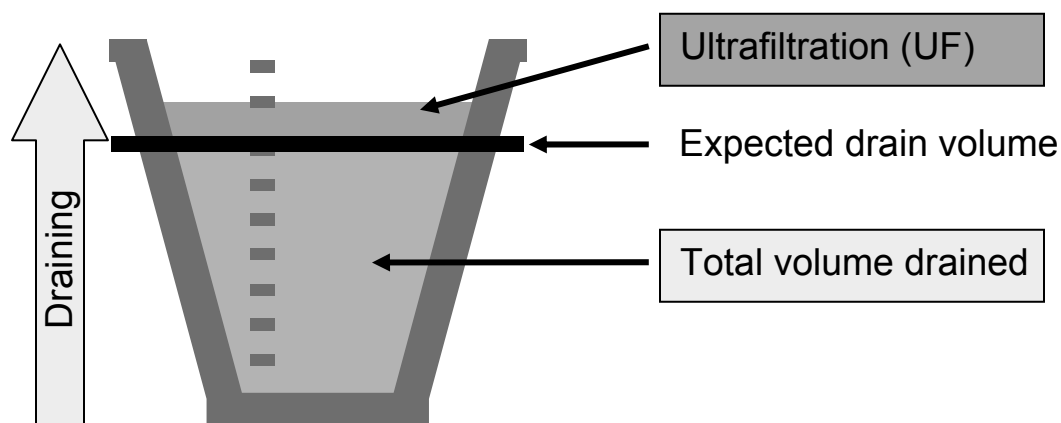

Note: The values shown here are for example only. You must use the values prescribed by your doctor.

Drain 0

Drain 0 is the Drain that starts your treatment. Drain 0 does not count toward your total ultrafiltration (UF) for the entire treatment unless the ‘Add diurnal UF’ option was set to YES (see page 80).



Warning: Do not bypass Drain 0 unless you have discussed your situation with your PD nurse or physician. For information on bypassing an exchange, see page 158.



Note: Use the clear ‘pillow’ on your drain line to look at the dialysate fluid as your cyclor pumps it to the drain. You may need to turn the pillow upside down to allow the fluid to collect in it. If your dialysate fluid is not clear, save a fluid sample and contact your PD nurse.

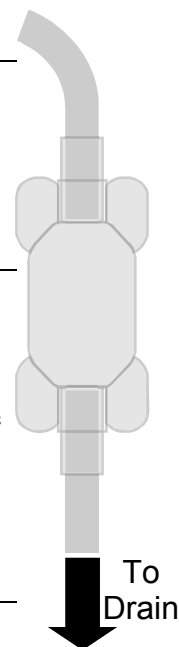

All Drain screens

The “Drain” screen displays a graph to track your Drain progress. As your cyclor drains you, the fluid level in the container on the left will rise.

You will continue to drain until the graph rises to the black line. This black line is your expected drain volume. This is based on your prescription.

When your cyclor drains more fluid than you filled with, this is called ultrafiltration. The graph will show the fluid level rise past the black line. Any ultrafiltration is shown in orange above the black line on the cup.



Note: You may drain more quickly sitting or standing up than lying down. There is more pressure on your abdomen in a sitting or standing position.

Note: If you need to stop the draining process, press the **STOP** key. The pump will stop and the “Draining Stopped” screen will be displayed. Draining will resume when you press the **OK** key.

When the Drain is complete, your cyclor will either begin to Fill you with fresh dialysate or end your treatment. If you are ending your exchanges with a Drain and this is the last Drain of your treatment, then turn to “Ending Treatment” on page 130. For Fills, see the Fill explanation on the next page.

Exchange: Fill1

Fill 1 of 2

My Treatment My Settings My Records

3/18/2009 10:22 AM

Volume set
1500 mL

Volume filled
1000 mL



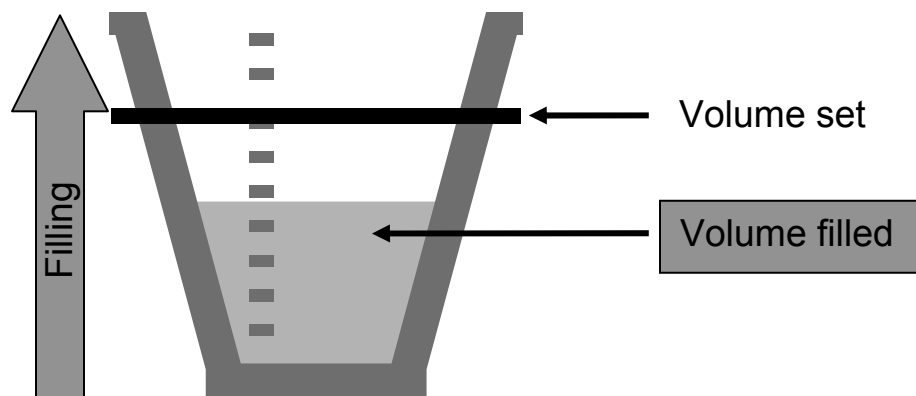

Note: The values shown here are for example only. You must use the values prescribed by your doctor.

Fill 1

Fill 1 is the first Fill of your treatment. Your cycler will always go to Fill 1 after Drain 0.

All Fill screens

The “Fill” screen displays a graph to track your Fill progress. As your cycler fills you, the fluid level in the picture on the left will rise. The black line indicates the expected fill volume level.

You will continue to fill until the graph rises to the black line. This black line is your set fill volume. This is based on your prescription.



Warning: If you feel a large, painful build-up of pressure during your fill, do not finish your fill cycle. You must press the **STOP** key to stop your cycler immediately then call your PD nurse or doctor. Overfilling can cause serious injury or death. For more information on overfilling, see page 158.



Note: You may fill more quickly lying down than sitting or standing up. There is less pressure on your abdomen in a lying down position.

Note: If you need to stop the Fill process, press the **STOP** key. The pump will stop and the “Filling Stopped” screen will be displayed. Filling will resume when you press the **OK** key.

Note: Your cycler will delay your Fill if the heater bag solution temperature is colder than 33°C (91.4°F). When the temperature reaches at least 25°C (77°F), your cycler will display the message “Press OK key to start fill...” If you press the **OK** key, you will begin your Fill with the cool solution. If the cool solution makes you feel uncomfortable, do not press the **OK** key. You must then wait until the solution has warmed up to the set temperature.

When the Fill is complete, your cycler will go to Dwell (page 126) or Pause (page 122) depending on your therapy.

If you have programmed a Last Fill, and this is the last Fill of your treatment, then turn to “Ending Treatment” on page 130.

Exchange: Pause

Pause 1 of 2

3/18/2009 10:32 AM

My Treatment My Settings My Records

Pause time
0 h 10 min

Push in the pin
THEN close the
blue line clamp and
your catheter clamp

Use aseptic
technique to
disconnect yourself

Press next to continue

Next ▶

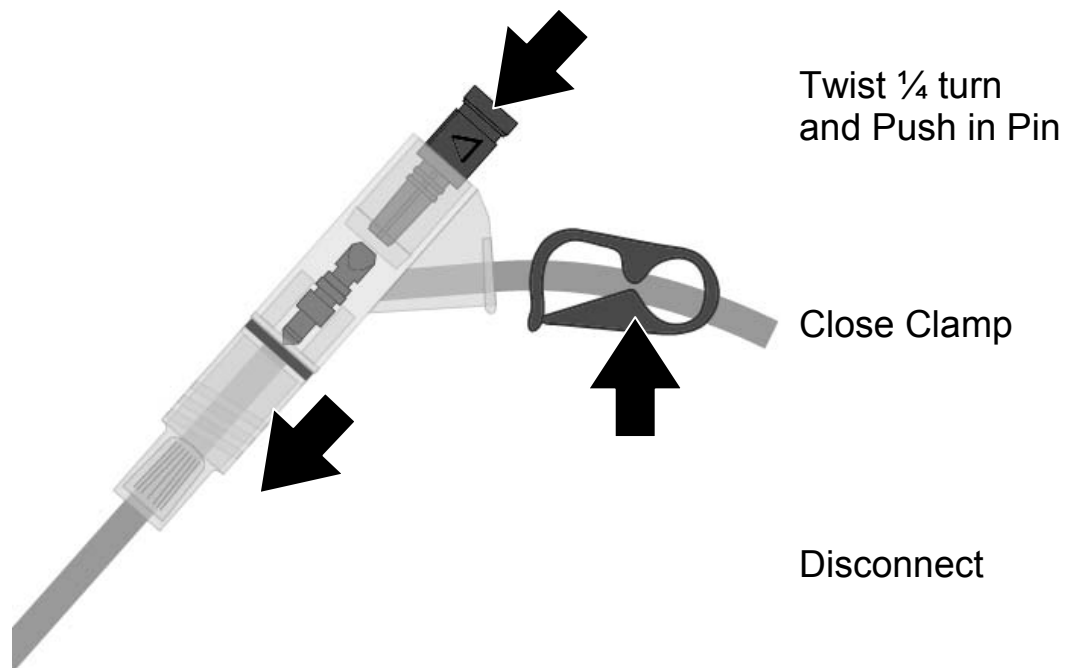
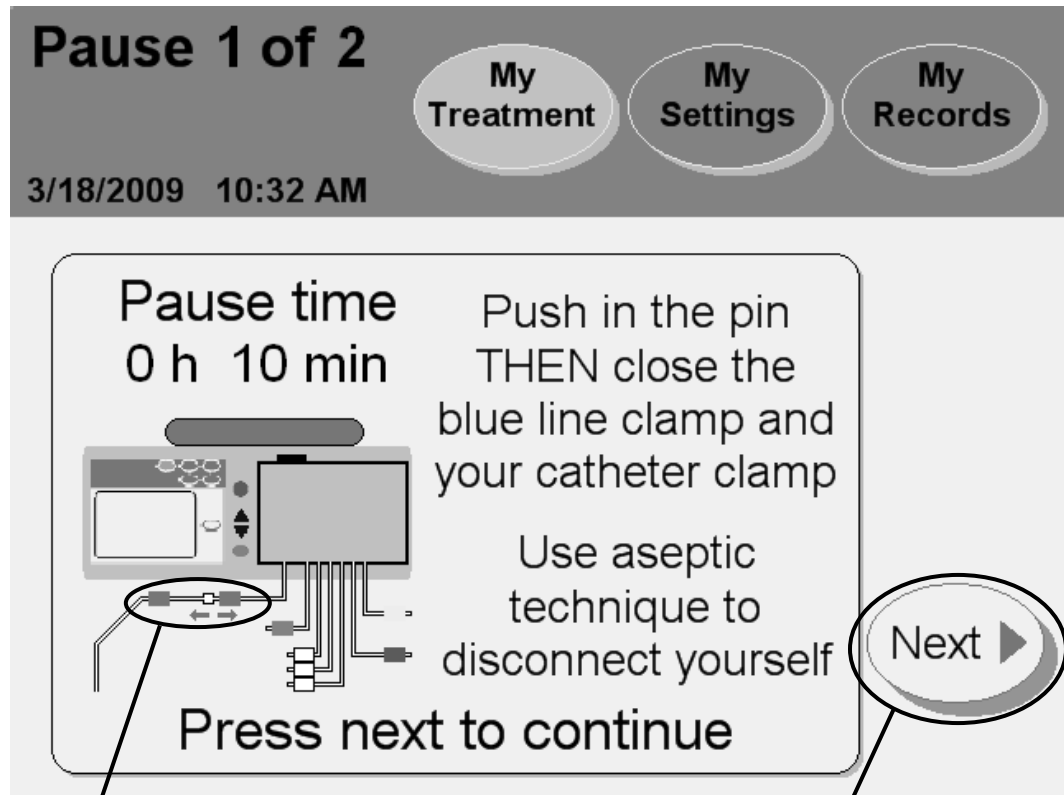

1 Pause: Disconnect from cyclor

A Pause is a special type of Dwell. During a Pause you still Dwell with the solution, but you may choose to disconnect from your cyclor. It is also different from other Dwells because it is not timed, meaning you may pause for as long as you need. The number of Pauses during your treatment depends on your prescription; see “My Treatment Parameters” on page 2.

When your cyclor is on the “Paused” screen, you may disconnect from your machine.



Warning: You must use aseptic technique as directed by your PD nurse to prevent infection.

Warning: Use a new, sterile stay•safe connector and cap every time you disconnect from your cyclor. Be sure to insert the new, sterile cap into the stay•safe system New Cap Holder before you disconnect.

To disconnect from your cyclor:

- Push in the pin—twist the pin ¼ turn and then push it in to make sure that a new pin is inserted in the line
- Close blue patient line clamp
- Close catheter extension clamp
- Carefully disconnect the patient line from your extension set and cap off with a new sterile stay•safe cap
- Check that your catheter/extension set is firmly anchored in place

Your cyclor will display how long you Pause under ‘Pause time’.

2 Touch **Next**

You may now leave your machine. Touch the **Next** button when you are ready to reconnect to your cyclor.



Note: The **Next** button is not available until your cyclor has finished filling up the heater bag.

Exchange: Pause Re-Start

Pause 1 of 2 Re-Start

3/18/2009 10:50 AM

My
Treatment

My
Settings

My
Records

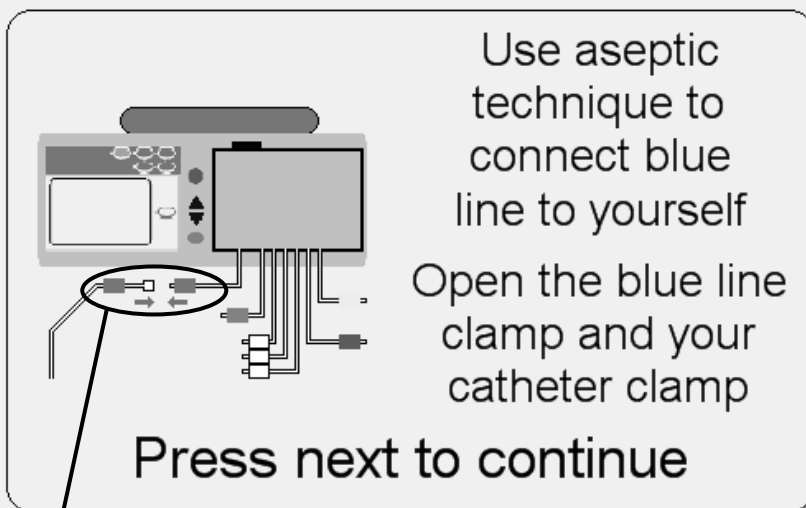

Use aseptic technique to connect blue line to yourself
Open the blue line clamp and your catheter clamp
Press next to continue

Next ▶

3

4

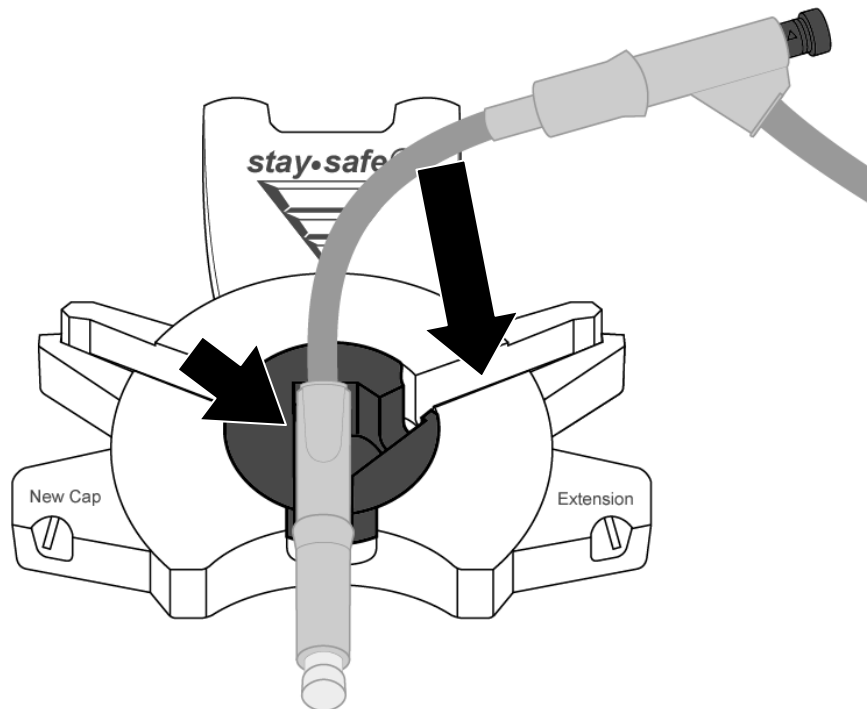

3 Reconnect to your cyclor

Reconnect to your machine when you are ready to resume your treatment. Be sure to remove your used stay•safe connector from its holder before beginning.



Warning: You must use aseptic technique as directed by your PD nurse to prevent infection. Wear a mask and wash your hands before reconnecting.

To reconnect to your cyclor:

- Put on your mask
- Wash your hands
- Insert the next stay•safe connector on your patient line into the stay•safe organizer clip below the control panel
- Insert the tubing into the Tubing Channel on the right
- Remove the clear stay•safe cap from the stay•safe connector
- Connect your catheter extension line to the stay•safe connector on the blue patient line
- Open blue patient line clamp
- Open catheter extension clamp

4 Touch **Next**

When you touch the **Next** button, your machine will begin the Drain process. Turn to page 118 for more information on the Drain process.

Exchange: Dwell

Dwell 1 of 2

3/18/2009 1:36 PM

My Treatment My Settings My Records

Time remaining
1 h 30 min

Time set
2 h 0 min





Note: The values shown here are for example only. You must use the values prescribed by your doctor.

All Dwell screens

During a Dwell, you stay connected to your machine while your fluid dwells inside you. Most Dwells take place at night when you are sleeping.

The “Dwell” screen displays a timer to count down your Dwell time. During the Dwell stage, your machine will pump dialysate to the heater bag. The heater tray will then warm the solution for your next Fill.



Warning: During the heating process, the Heater Tray can get as hot as 50 °C (122 °F). Do not come into contact with the Heater Tray as it may cause injury.



Note: If you need to stop the dwell process, press the **STOP** key. The Dwell timer will stop counting down and the “Dwell Stopped” screen will be displayed. The Dwell will resume when you press the **OK** key.

Note: The cyclor cannot bypass an exchange while the heater bag is filling.

When your Dwell time is complete, your cyclor will Drain you again. See page 118 for more information on the Drain process.

This Page is Intentionally Blank

Ending Treatment

Ending Your Treatment

Treatment Complete
3/18/2009 1:43 PM

My Treatment My Settings My Records

step 8

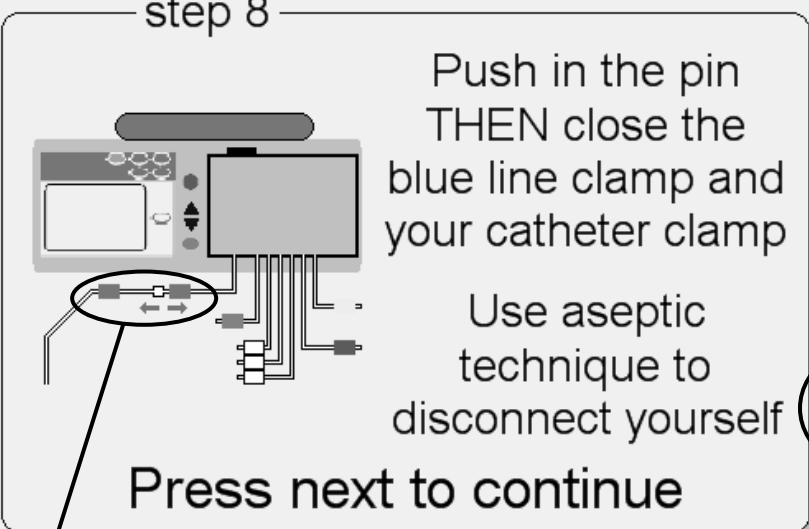

Push in the pin
THEN close the
blue line clamp and
your catheter clamp

Use aseptic
technique to
disconnect yourself

Press next to continue

Next ▶

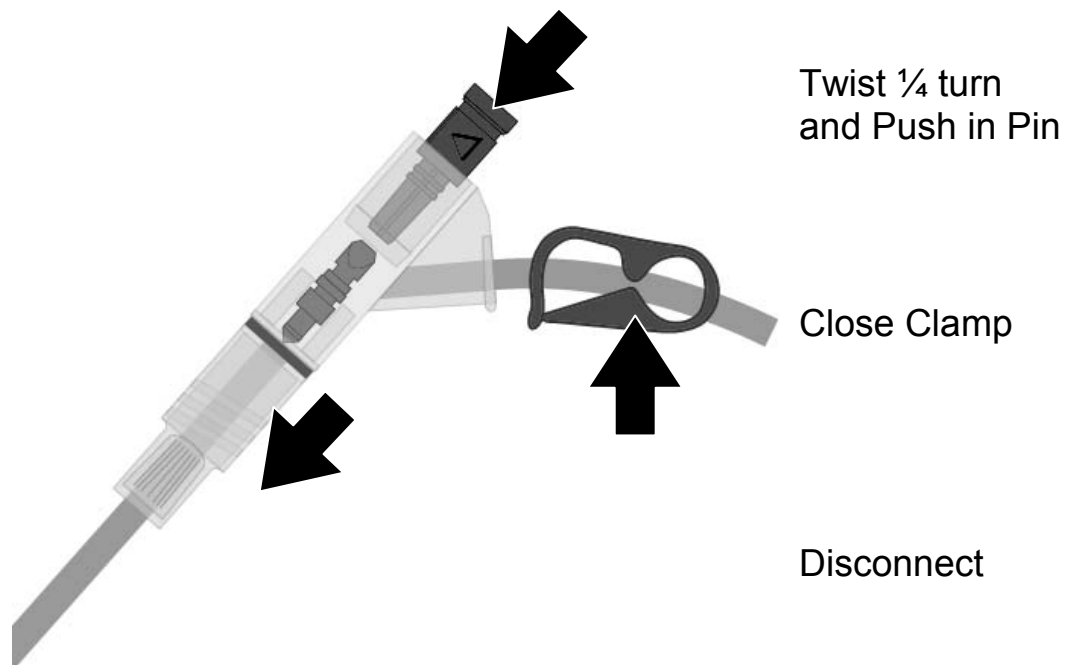

1 Disconnect yourself

After your last Drain or Fill of your treatment, your treatment will be complete for the day. When your cyclor reaches this screen, you may disconnect.



Warning: You must use aseptic technique as directed by your PD nurse to prevent infection.

Warning: Use a new, sterile stay•safe connector and cap every time you disconnect from your cyclor. Be sure to insert the new, sterile cap into the stay•safe system New Cap Holder before you disconnect.

To disconnect from your cyclor:

- Push in the pin—twist the pin ¼ turn and then push it in to make sure that a new pin is inserted in the line
- Close blue patient line clamp
- Close catheter extension clamp
- Carefully disconnect the patient line from your extension set and cap off with a new sterile stay•safe cap
- Check that your catheter/extension set is firmly anchored in place

2 Touch **Next**

Touch the **Next** button to continue. If you set the ‘personal data’ option to YES (see “Options Settings” on page 80), your cyclor will next go to the “Personal Data” screen. If the ‘personal data’ option is not set, turn to page 138.

Entering Your Personal Health Data

The screenshot shows the 'Patient Data' screen. At the top, there are three buttons: 'My Treatment', 'My Settings', and 'My Records'. Below them is the date and time: '11/3/2010 1:19 PM'. The main heading is 'Your personal health data' with the instruction 'Enter your health data below'. A table contains the following data:

dextrose 1.5%	last bag type	pulse
500 mL	1.5	60
dextrose 2.5%	blood glucose	blood pressure
500 mL	104 mg/dL	120 / 70
dextrose 4.25%	weight	temperature
1000 mL	100 lbs	98.5 °F

Below the table is a 'Next' button with a right-pointing arrow. To the right of the screen are several navigation buttons: a stop button, up and down arrow buttons, and a circular button. Callout 3 points to the table, callout 4 points to the 'Next' button, and callout 5 points to the circular button.



Note: The values shown here are for example only. You must use the values prescribed by your doctor.



Note: This screen will appear only if you set the ‘personal data’ option to YES. See “Options Settings,” on page 80.

You must enter your personal data now—you cannot edit this screen later.

3 Select values

Here you need to update your personal health data. Touch the yellow button to select the value it displays:

- **Dextrose 1.5%**—The volume of dextrose 1.5% used during treatment
- **Dextrose 2.5%**—The volume of dextrose 2.5% used during treatment
- **Dextrose 4.25%**—The volume of dextrose 4.25% used during treatment
- **Last Bag Type**—Dextrose type of the last bag used (1.5, 2.5, or 4.25)
- **Blood glucose**—Your blood glucose level
- **Patient Weight**—Your weight after your treatment
- **Pulse**—Your pulse in beats per minute
- **Blood pressure**—Measure your blood pressure as directed by your PD nurse. Touch the **blood pressure** button to select it, then use the **Up/Down Arrow (▼/▲)** keys to change the first number (systolic). Press the **OK** key to confirm the selection. Use the **Up/Down Arrow (▼/▲)** keys to set the next number (diastolic) and press the **OK** key again to confirm the selection.
- **Temperature**—Measure and enter your temperature as directed by your PD nurse



Note: These values must be properly measured to determine the effectiveness of your treatment.

4 Enter values

When you touch a yellow button, it will turn orange. Use the **Up/Down Arrow (▼/▲)** keys to set it to your measured values. Repeat these steps to enter all of your information.

When you are finished entering all your data, press the **OK** key to confirm the selections.

5 Touch **Next**

After pressing the **OK** key, touch the **Next** button to continue. If you press **Next** without entering your Personal Data, no information will be recorded for this date.

Your Treatment Summary

Treatment Summary
3/18/2009 1:59 PM

My Treatment My Settings My Records

Your treatment summary

total time 7 hr 15 min	dwelt time lost 0 hr 3 min
total UF 454 mL	last fill volume 2000 mL
total volume 7999 mL	

Details

Next ▶

Press next to continue

6

7



Note: The values shown here are for example only. You must use the values prescribed by your doctor.

6 Review Treatment Summary

This screen displays a summary of your last treatment. Your total time, UF, and volume are listed. More specific information is stored in the “Details” screen, available through the **Details** button on the right side of the screen or within the **My Records** screen-button along the top.



Note: You may touch the **Details** button for more information about your latest treatment. The “Details” screen displays information about exchanges, times and volumes. See the next page for more information about this screen.

Note: Your cyclor is designed to complete your treatment on time. If, within that time, the dwell was longer than expected (due to an alarm), the **Dwell Time** button will display the word ‘gained’ before the time. If the dwell was shorter than expected (due to a drain or fill bypass), the **Dwell Time** button will display the word ‘lost’ before the time.

7 Touch **Next**

Touch the **Next** button when you are finished reviewing your treatment. Turn to page 138 to continue.

Treatment Summary continued

Treatment Summary

My Treatment
My Settings
My Records

11/4/2010 11:30 AM

Your treatment details for **11/4/2010**

cycle #	fill		dwell time	drain		UF vol
	vol	time		vol	time	
0				1900	20	-100
1	2000	15B	60P	2100	18	100
2	2000	13S	120	2100	21B	100
3	2000	15	90S	2000	20	0
4	2000	16F	120	2000	20	0
5	2000	14				

all volumes in mL
all times in min

net UF: 200



review



return

 **Note:** The values shown here are for example only. You must use the values prescribed by your doctor.

Review Treatment Details

This screen displays the cycles of your last treatment. Your information is listed by cycle number and includes:

- Fill volume
- Fill time
- Dwell time
- Drain volume
- Drain time
- Ultrafiltration volume



Note: If the Drain, Fill, Dwell, or Pause times were interrupted at all, the following letters will appear next to the time to show the interruption:

F – Power Failure

B – Bypass

P – Paused

S – STAT Drain

Touch **Back**

Touch the **Back** button to return to the “Treatment Summary” screen. Then, to continue to the next step on the next page, touch the **Next** button when on the “Treatment Summary” screen.

Remove Set Screen 1

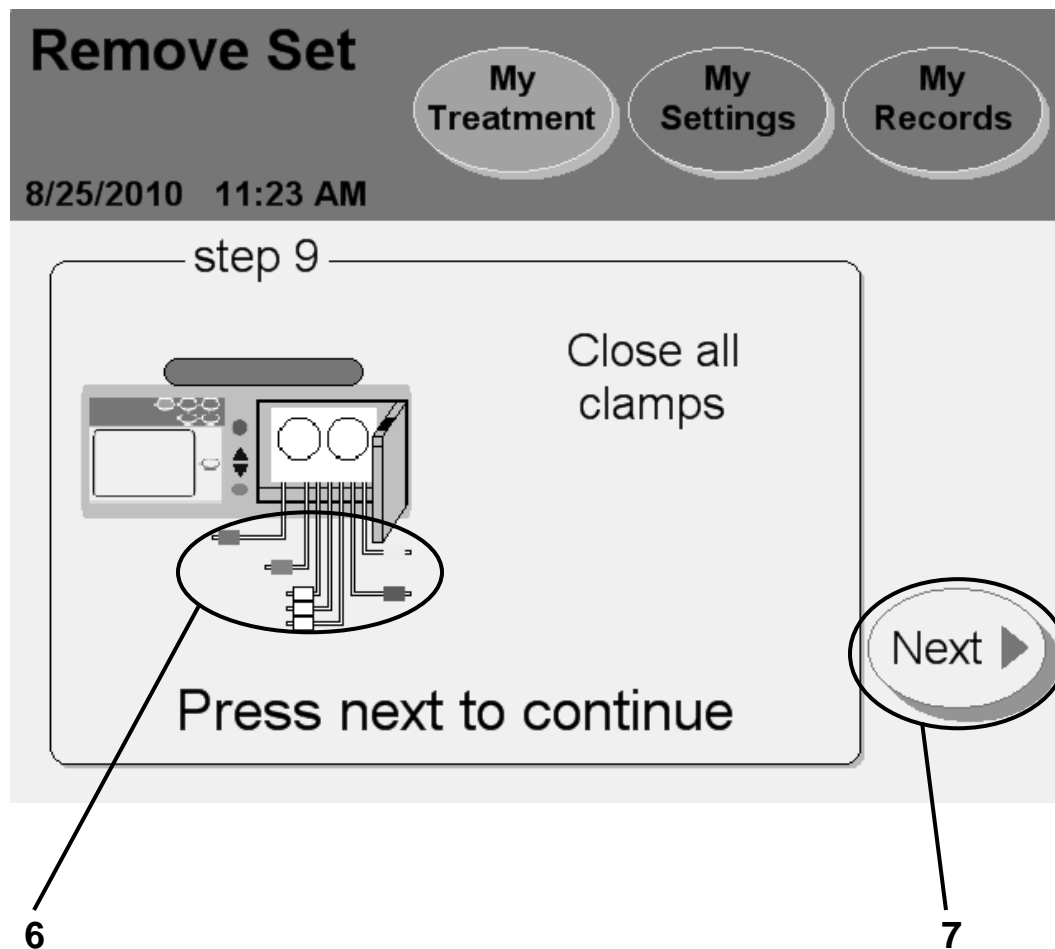

6 Close all clamps

Clamp all lines to prevent any fluid spills when removing the disposable set.



Note: Clamp all lines to prevent spills. Spills can cause damage to carpeting and other surfaces. To contain such spills, your machine should be on a spill-tolerant surface. Clean up spills immediately.

7 Touch **Next**

Touch the **Next** button to continue to the next step.

Remove Set Screen 2

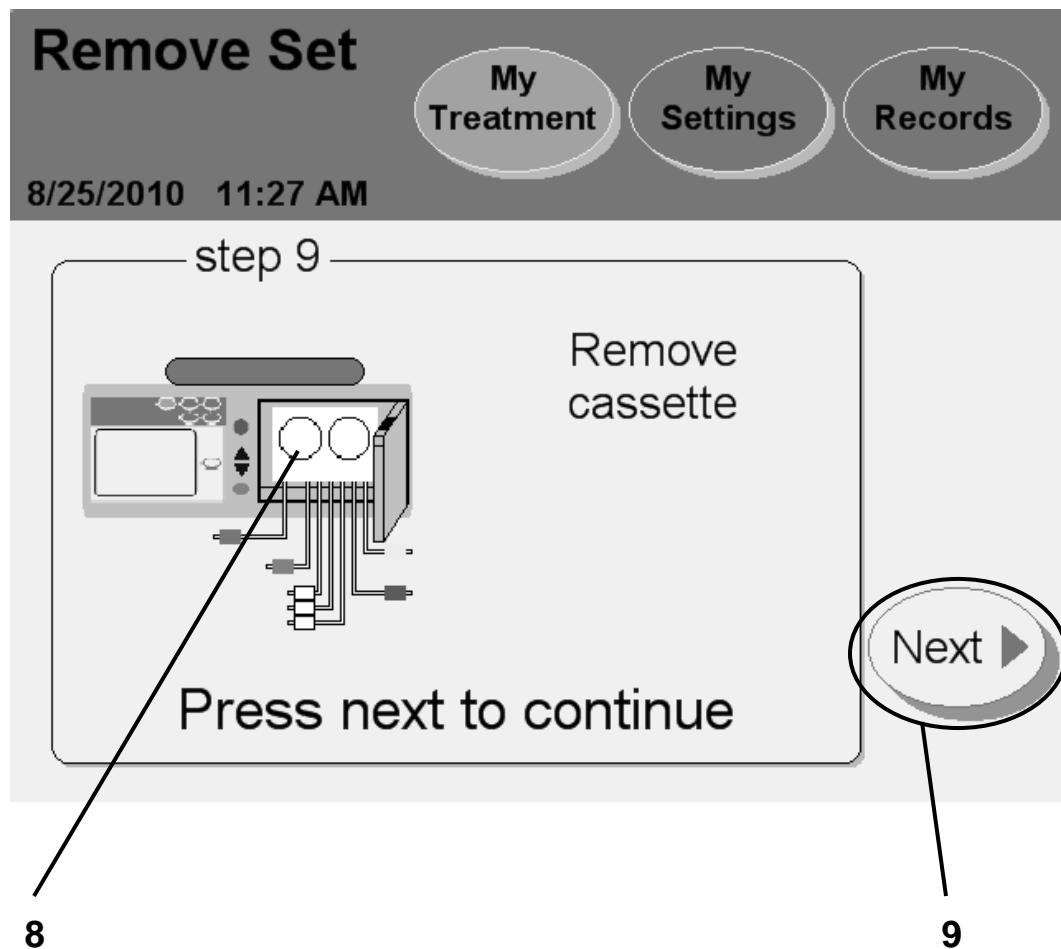

8 Remove cassette

Push the door latch to open the cassette door.



Warning: Be careful of pinch points in moving parts, injury may occur.

Remove the cassette from your machine. Discard your waste materials as instructed.



Caution: If your pump module has moisture in it, your cassette may have a leak. Save your cassette and call Technical Support immediately at 1 800 227-2572

You should also clean your machine at this time. Follow your healthcare staff's instructions. See "Cleaning Your Cyclor," on page 200.

Close and latch the cassette door again.

9 Touch **Next**

The **Next** button will appear after the door has been closed. Touch the **Next** button to continue.

Power Down Cyclers

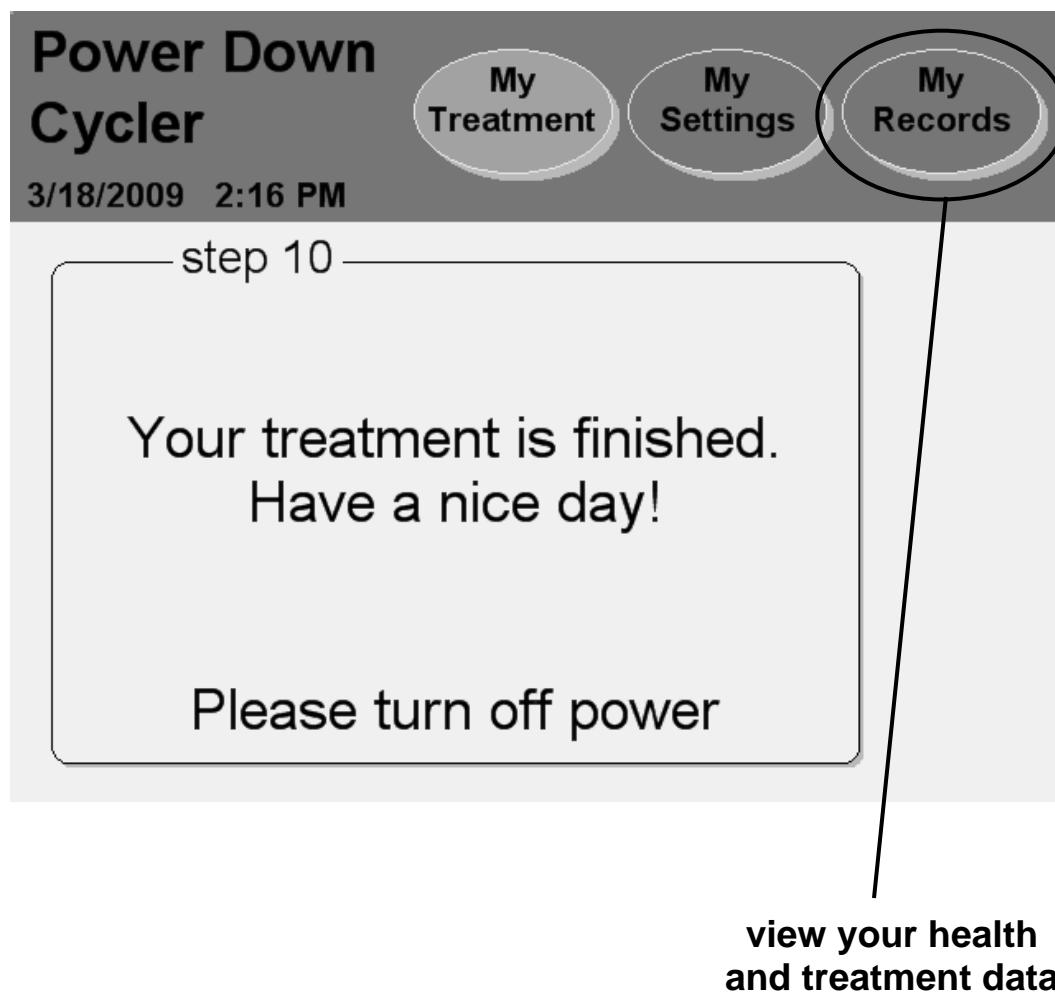

Have a nice day

Locate the switch on the back of your cyclor and turn it off.

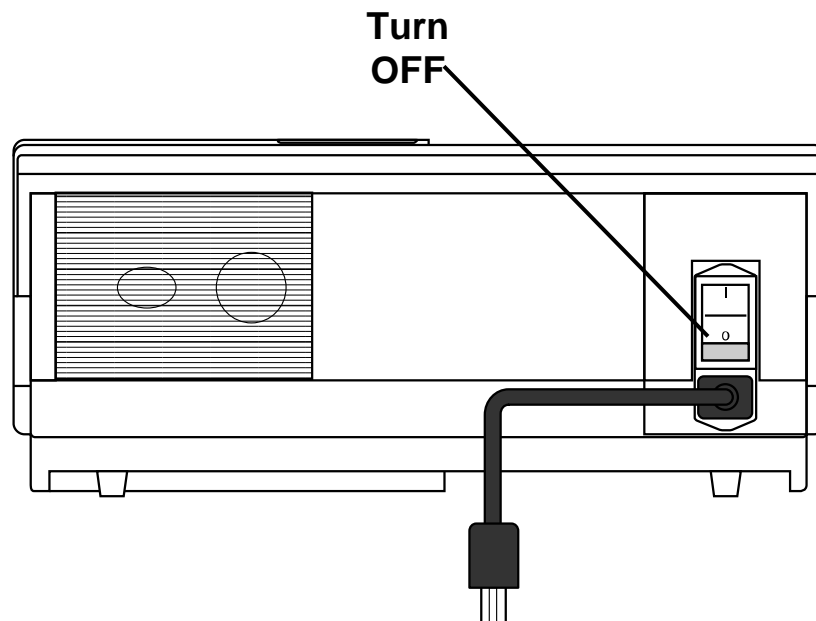

You will need to power on your cyclor again before your next treatment.

If you need to remove your IQdrive to take it to your PD nurse, you may safely remove it at this time.



Caution: Handle your IQdrive with care. When taking your IQdrive to and from your healthcare provider, store it in a plastic bag and keep it clean and dry. Do not leave your IQdrive in a hot car or in the bottom of a purse where it can become damaged.

Touch **My Records**

If you would like to further review your treatment information, restart your cyclor and touch the **My Records** screen-button. See page 148 for an explanation of the “My Records” screen.

This Page is Intentionally Blank

Appendix

Appendix

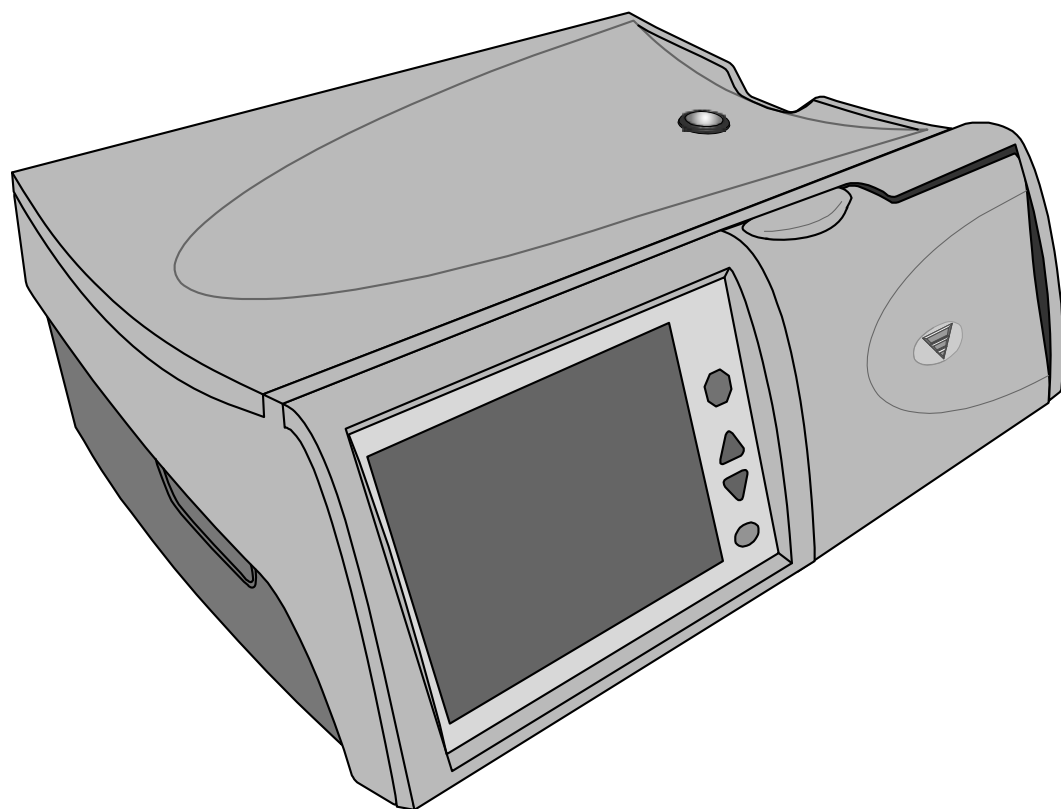

Appendix

The Appendix explains helpful instructions on different features that you may not use every treatment:

- Viewing the “My Records” screens—Turn to page 148
- Using the STOP key—Turn to page 154
- Using the STAT Drain—Turn to page 156
- Bypassing an exchange—Turn to page 158
- Using the IQdrive—Turn to page 162
- Moving your Liberty cyclers—Turn to page 166

If you get ‘lost’ in any of these screens, simply touch the **Back** button, if available, to go to a previous screen. You may also touch any screen-button in the Status Bar to view other screens. See page 30 for more information on screen-buttons.

The My Records Screen-Button

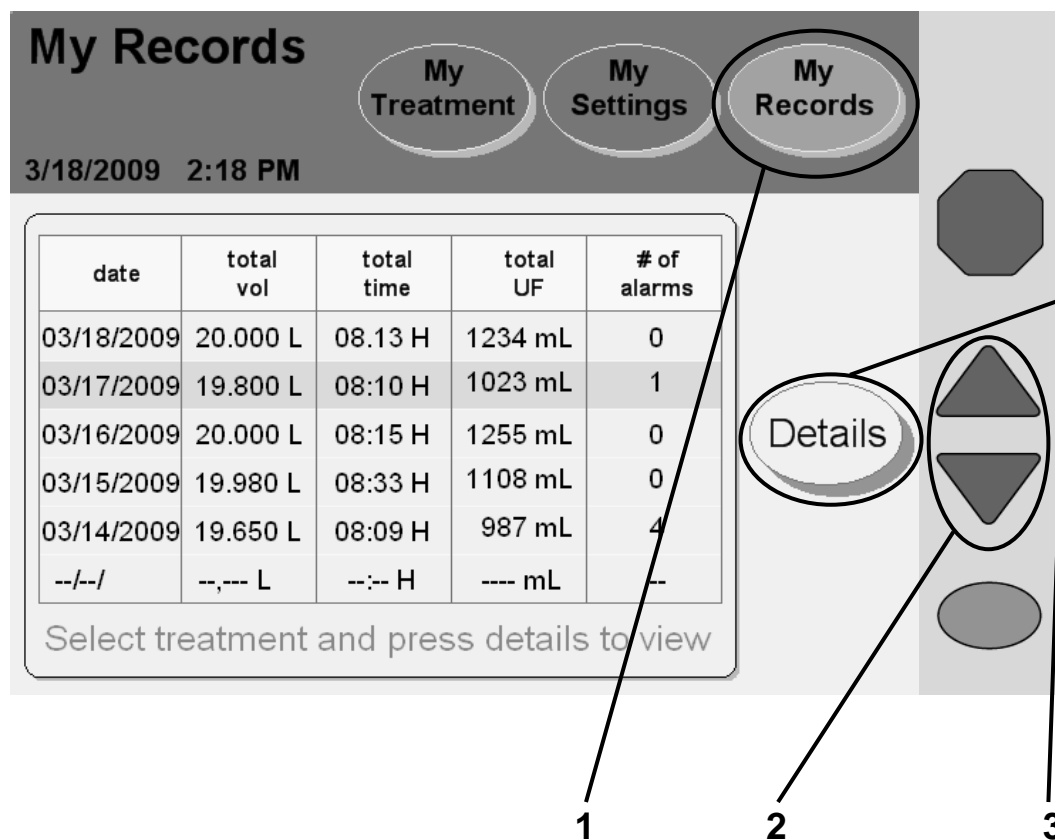

Note: The values shown here are for example only. You must use the values prescribed by your doctor.

1 Touch **My Records**

Your treatment history is a record of your past treatments. Your cyclor saved all the information here during each of your treatments. You cannot change any of the information here. This information is for you and your PD nurse to review.

You may reach the “My Records” screen from any other screen. Touch the **My Records** screen-button to view your treatment history.

2 Select treatment date to view

The select treatment table displays your last six treatments in the main area. Use the **Up/Down Arrow (▼/▲)** keys to scroll through the different pages of your treatments to see older treatment dates, if desired. Touching a treatment date will select that treatment by highlighting it with a blue bar.

Your cyclor saves your last three months of treatment data.

3 Touch **Details**

Touch the **Details** button to view the treatment details for the selected date.

Treatment Details

My Records

My Treatment My Settings My Records

11/4/2010 11:30 AM

Your treatment details for **2/7/2007**

cycle #	fill		dwell time	drain		UF vol
	vol	time		vol	time	
0				1900	20	-100
1	2000	15B	60P	2100	18	100
2	2000	13S	120	2100	21B	100
3	2000	15	90S	2000	20	0
4	2000	16F	120	2000	20	0
5	2000	14				

all volumes in mL
all times in min

net UF: 200

Back

Next

4

5

 **Note:** The values shown here are for example only. You must use the values prescribed by your doctor.

4 View treatment details

This screen shows information about the selected treatment date. The treatment date is displayed at the top of the Main Area. The information is organized by the cycle number (#) and shows:

- Fill volume
- Fill time
- Dwell time
- Drain volume
- Drain time
- Ultrafiltration volume



Note: If the Drain, Fill, Dwell, or Pause times were interrupted at all, the following letters will appear next to the time to show the interruption:

F – Power Failure

B – Bypass

P – Paused

S – STAT Drain

Note: To go back and select a new treatment date, touch the **Back** button.

5 Touch **Next**

Touch the **Next** button to view your personal health data for the selected treatment.

Your Personal Health Data

My Records

11/4/2010 11:29 AM

My Treatment My Settings My Records

Your personal health data

dextrose 1.5%	last bag type	pulse
500 mL	1.5	60
dextrose 2.5%	blood glucose	blood pressure
500 mL	104 mg/dL	120/70
dextrose 4.25%	weight	temperature
1000 mL	100 lbs	98.5 °F

6

7

Back

The screenshot shows a mobile application interface. At the top, there's a dark header with the title 'My Records' and three circular buttons: 'My Treatment', 'My Settings', and 'My Records'. Below the header, the date and time '11/4/2010 11:29 AM' are displayed. The main content area is titled 'Your personal health data' and contains a table with three columns and three rows of data. A 'Back' button with a left-pointing arrow is located to the right of the table. Two callout lines with numbers '6' and '7' point to the table and the 'Back' button, respectively.



Note: The values shown here are for example only. You must use the values prescribed by your doctor.

6 View screen details

This screen displays the personal data you entered at the end of your treatment (see page 132). If you did not enter any data at that time, the field will display 'N/A' for Not Available. The “Your Personal Health Data” screen shows:

- Dextrose 1.5%
- Dextrose 2.5%
- Dextrose 4.25%
- Last bag type
- The weight you entered after treatment
- Blood glucose
- Pulse
- Blood Pressure
- Temperature

7 Touch

Touch the **Back** button to return to the “Your Health Data” screen.



Note: You may touch any of the screen-buttons in the Status Bar to exit the “Personal Health Data” screens.

Using the STOP key

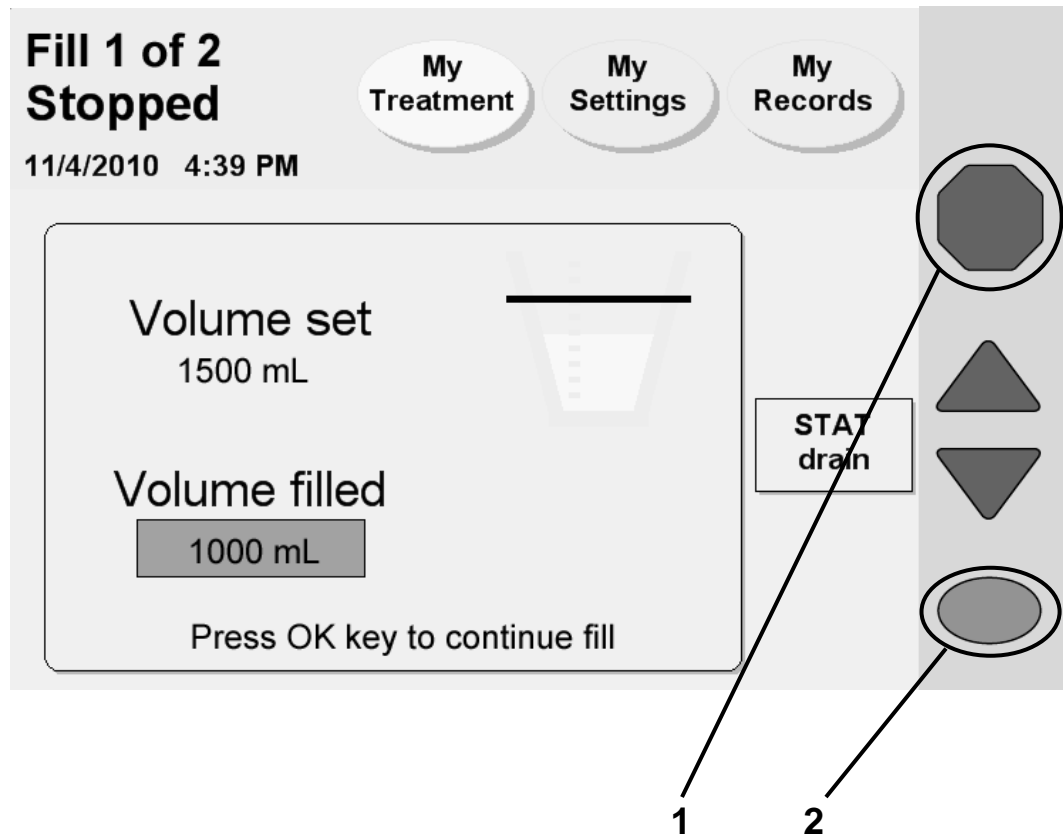

1 Press **STOP**

If it is absolutely necessary to stop your machine when it is performing an action, you may press the **STOP** key. The following green Status Bar machine functions may be stopped:

- Flush
- Prime
- Bag Detect
- Heating
- Drain
- Fill
- Dwell



Note: If you are performing a Fill, Dwell, or Pause, you may choose to do an immediate (STAT) drain at this time. Do not press the **OK** key on your cyclor; instead turn to the next page of this manual for instructions on performing a STAT drain.

2 Press **OK** when you are ready to continue

When your cyclor is stopped, the following occurs:

- The pump motor stops
- The Status Bar changes to yellow
- The word 'stopped' appears at the top of the screen
- The words 'press OK to continue' are displayed at the bottom of the screen.

When you are ready to continue, press the **OK** key.

Using the STAT Drain

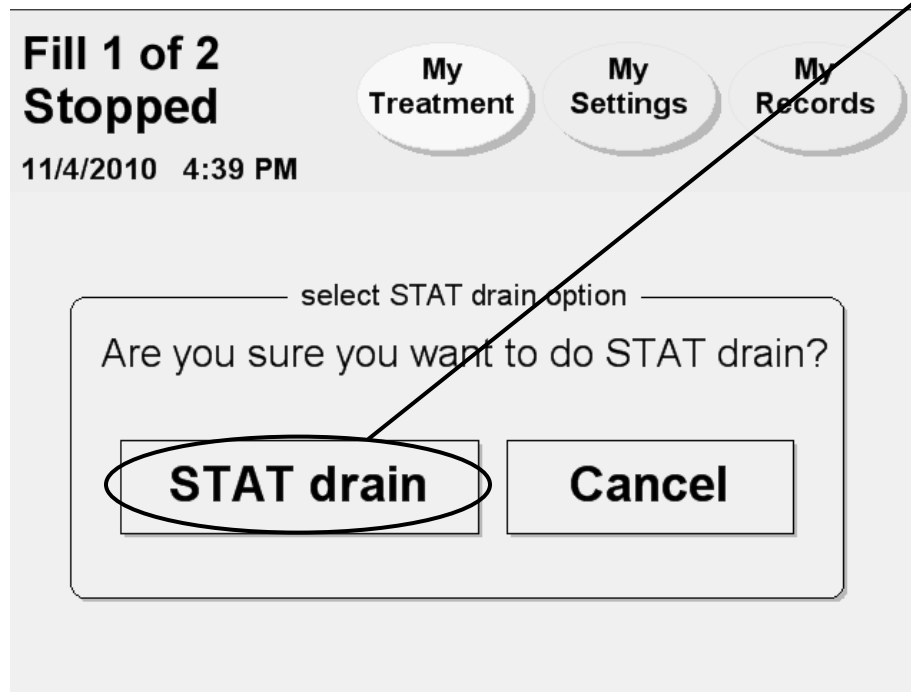
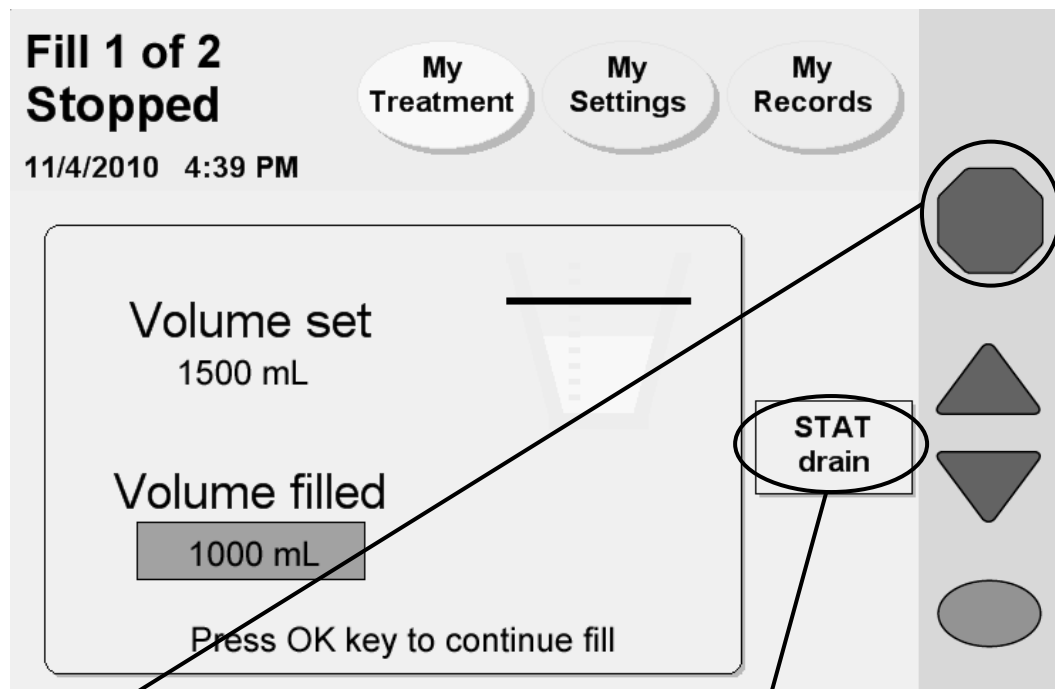

1 Press **STOP**

If you are performing a Fill, Dwell, or Pause, you may choose to do a STAT (immediate) drain. This unscheduled Drain will interrupt your Fill, Dwell, or Pause. Press the **STOP** key to first stop your Fill, Dwell, or Pause.

2 Touch **STAT drain**

After the “Stopped” screen displays the message “Press OK key to continue fill,” touch the **STAT drain** button.

3 Touch **STAT drain** on the next screen

Your cyclor will display the “Select STAT drain option” screen. To continue with the STAT drain, touch the **STAT drain** button.

If you were previously in a Fill or Dwell cycle, the STAT drain will immediately begin draining your abdomen.

If you were previously in a Pause cycle, your cyclor will ask you to reconnect first. See page 124 for information on how to reconnect after a Pause. After you reconnect, the STAT drain will immediately begin draining your abdomen.

During a STAT drain, your cyclor will display a “Drain” screen with the word ‘STAT’ in the upper left corner to show that it is running an unscheduled drain.



Note: A STAT Drain works the same as a regular Drain. You may stop it or bypass it as needed.

After your STAT drain is complete, your cyclor will either begin a short Dwell or Pause (depending on which cycle you interrupted) so your cyclor can prepare the heater bag for your next cycle. Afterward, your cyclor will begin your next programmed Fill, if required. Your treatment data will show that you performed a STAT drain (see page 148 for more information).

If you instead do not want to run a STAT drain, either touch the **Cancel** button or wait 10 seconds. Your cyclor will go back to the “Stopped” screen (see page 154).

Bypassing an Exchange

Normal Treatment with Prescribed Drain 0

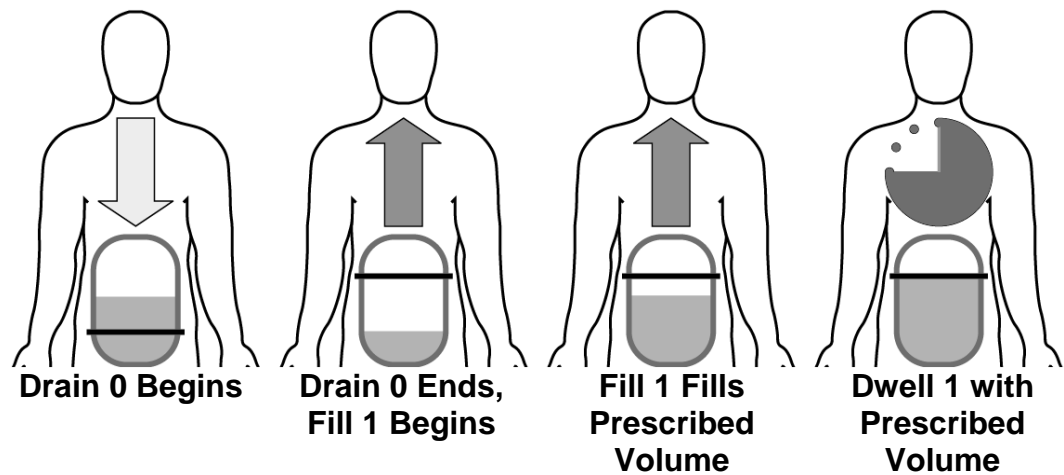

Drain 0 Bypassed With Undrained Peritoneal Cavity (Scenario 2)

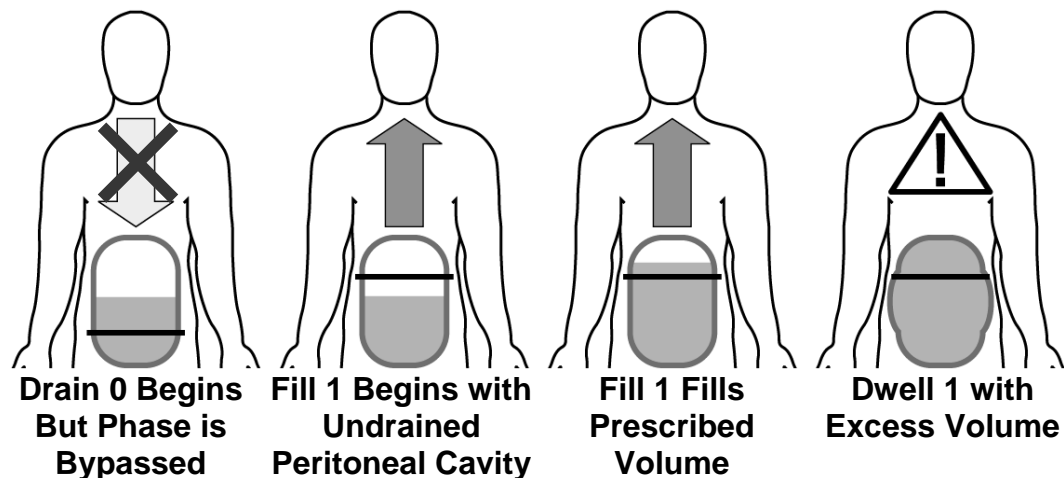

Bypassing an exchange

A bypass is the manual skipping of an exchange. Your cyclor will not allow you bypass any Drain phase after Drain 0 if there is a danger of overfilling. However, Drain 0 may be bypassed at any time. Before bypassing you must consider that there are three different scenarios that could occur, depending on your prescription. You and your PD nurse must choose the situation that best describes you:

1. *You do not have a Last Fill programmed* and therefore have a ‘dry day’ or very little fluid left in your abdomen. Your cyclor will attempt to drain 70% of 50 mL (35 mL) of fluid before switching to Fill 1. You can safely bypass Drain 0 during this time.
2. *You do one or more manual daytime exchanges that you did not program into your cyclor (see page 108).* In this case, your cyclor does not know that you have additional fluid in your abdomen, so you must NOT bypass Drain 0. Wait for your cyclor to finish draining you before continuing to Fill 1.
3. *You have a Last Fill programmed.* During Drain 0 your cyclor will try to drain at least 70% of your last fill volume. Your cyclor may or may not be able to drain all of the fluid out because your body might have re-absorbed some of the fluid. If you are receiving alarms, talk with your PD nurse to decide if you should bypass.

It is important to understand the dangers of overfilling. Overfilling or Increased Intraperitoneal Volume (IIPV) of the abdominal cavity is when you have a amount of fluid in your abdomen that is larger than your prescribed fill volume: IIPV may result in serious injury or death from conditions such as: abdominal wall and/or diaphragmatic hernias, hydrothorax, heart failure, acute hypertension, pulmonary edema, decreased pulmonary function and pericardial effusion.

Patients and caregivers should watch for the potential signs of IIPV. These include: difficulty breathing; vomiting or spitting up; feeling full, bloated, or overfilled after treatment; abdominal pain or discomfort; expanded or tense abdomen; localized swelling around the genital area, navel, or tunnel tract of the peritoneal dialysis catheter or the PD catheter exit site; leakage of fluid from the PD catheter exit site; and unexpected increase in blood pressure. Contact your doctor or PD nurse if any of these symptoms occur.

Bypassing an Exchange (continued)

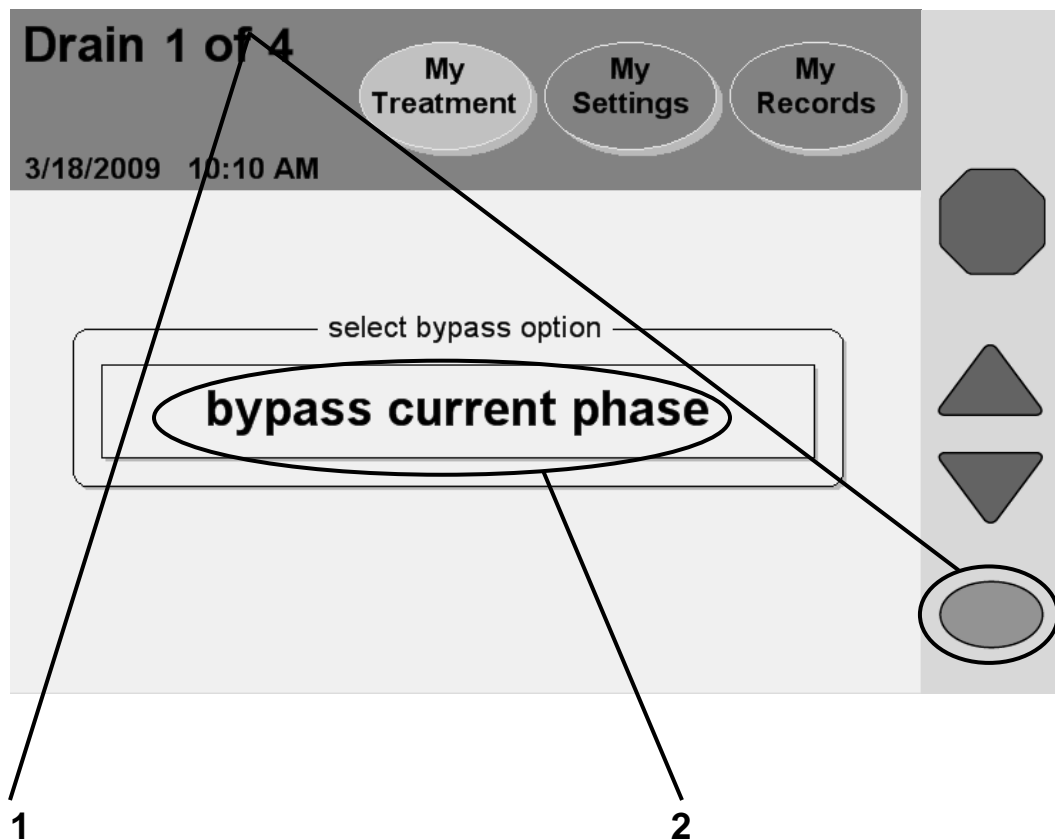

Note: If you accidentally reach this screen and do not want to bypass the current phase, wait a few seconds and you will return to the previous screen.

1 Press and hold **OK** for four seconds

Bypassing (or skipping) any phase of your treatment should be avoided unless you've discussed situations that may require bypassing with your doctor or PD nurse.

If you must bypass a Drain, Fill, or Dwell phase, pressing and holding the **OK** key for four seconds will display the "bypass current phase" screen.

2 Touch **bypass current phase**

Touch the **bypass current phase** button to skip the current phase and continue to your next exchange.

If your cyclor calculates that there is still too much fluid in your abdomen, you may not bypass. Your cyclor will then display a blinking message, "bypass not allowed at this time" and then go back to the previous screen. You must wait as your cyclor drains more fluid from your abdomen before trying to bypass again.



Warning: If you feel a large, painful build-up of pressure during your fill or any of the signs listed on page 158, do not finish your fill cycle. You must press the **STOP** key to stop your cyclor immediately then call your PD nurse or doctor. Overfilling can cause serious injury or death.

Warning: Do not bypass Drain 0 if you have a last fill programmed or if you turn off your cyclor after you have filled. Do not also then bypass Fill1 if you have a Pause programmed. You must make sure that you have drained enough fluid from your abdomen before bypassing Drain 0. Failure to do so could result in an overflow situation. Overfilling can cause serious injury or death.

Warning: If you do not program a manual daytime exchange into your Liberty cyclor, your cyclor will not know that you have additional fluid in your abdomen. Do NOT bypass Drain 0. Your Liberty cyclor will switch to Fill 1 when you are finished draining.



Note: If you bypass during a Fill or Dwell, you will either not receive your prescribed amount of dialysate or not have as much time to filter out the waste. Your treatment will not be as effective. The letter 'B' will also be displayed next to your treatment details in the "My Records" screen to show a bypass occurred. For more information, see "Treatment Details" on page 148.

Using the IQdrive

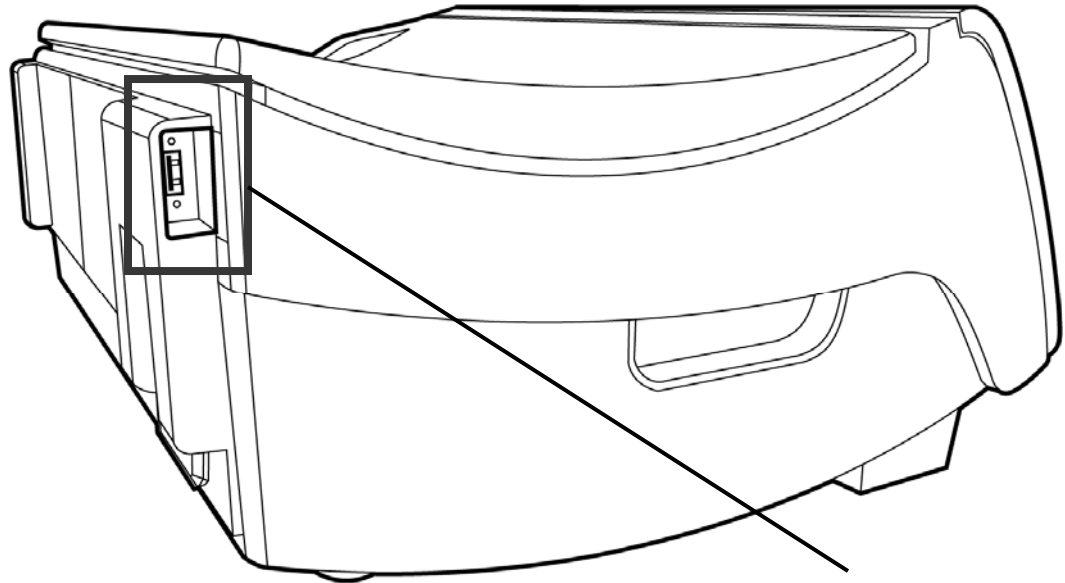

USB Port

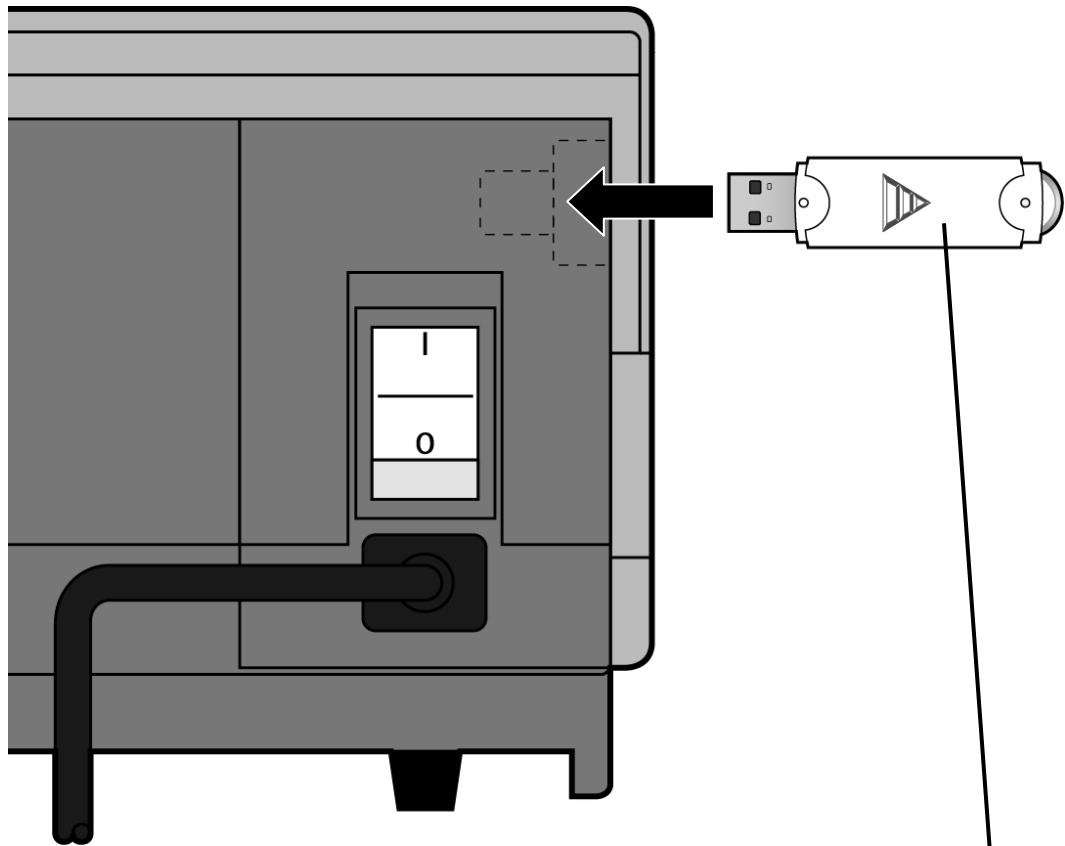

View From Back of Liberty Cycler

IQdrive

IQdrive overview

The IQdrive is a device used to transfer your prescription and treatment data. The 'USB enabled' option must be set to YES to access it (see page 80). Your healthcare staff will provide you with an IQdrive, program it with your therapy settings, and explain how to use it for record-keeping. The IQdrive fits into the USB port on the back of your cyclor.



Caution: Handle your IQdrive with care. When taking your IQdrive to and from your healthcare provider, store it in a plastic bag and keep it clean and dry. Do not leave your IQdrive in a hot car or in the bottom of a purse where it can become damaged.

Caution: Your Liberty cyclor IQdrive is only for use with your Liberty cyclor. Do not use your IQdrive to store your own data from other sources (for example, digital photos from your computer). Storing personal data on your IQdrive will corrupt your treatment data and your Liberty cyclor will no longer be able to record your treatment progress on your IQdrive. Your healthcare staff will then need to erase everything on your IQdrive and reformat it.



Note: If the 'USB enabled' option is set to YES but no IQdrive is inserted in the IQdrive slot upon power-up, you will have two choices: Either continue without using the IQdrive (by pressing the **OK** key) or insert the IQdrive immediately.

Inserting the IQdrive

Insert the rectangular metal end of the IQdrive into the slot (USB port) in the back, left corner of your cyclor as shown in the picture to the left. The little light on the end of the IQdrive will face away from the front of the machine. The IQdrive is keyed to fit in only one direction. If the device does not fit, turn it over and try again.



Note: If your cyclor displays the message, "IQdrive not detected," remove the IQdrive and firmly re-insert it to try again.

(continued on next page)

USB Upload

USB Upload

My Treatment My Settings My Records

6/4/2009 4:20 PM

Program cyclers with new IQdrive settings?

therapy PD+	total volume 10500 mL	total sleep time 8 hr 00 min	Accept
# fills 6	fill volume 2000 mL		
# pauses 1	pause volume 2000 mL	dwel time 1 hr 31 min	
	last fill volume 500 mL		

Reject

Current Settings

select option



Note: The values shown here are for example only. You must use the values prescribed by your doctor.

(continued)

USB Upload

The first time you insert the IQdrive and power-up your cyclor, this screen will be displayed. This screen will also be displayed if your PD nurse changes your prescription on the IQdrive.

The main area of the “USB Upload” screen displays the therapy settings to be uploaded onto your cyclor. You must carefully review them to make sure they match your doctor’s prescription.



Warning: Your doctor must prescribe your entire treatment. Using incorrect values could result in complications that may be severe.

To the right side are three buttons:

- **Accept**—Touch this button to use the new settings for your therapy.
- **Reject**—Touch this button if the IQdrive settings are incorrect. You will use the old therapy settings that are saved to your cyclor.
- **Current Settings**—Touch this button to review your old therapy settings. From that screen you may touch the **IQdrive Settings** button to return to this screen.

After selecting either **Accept** or **Reject**, you will move to the “Ready” screen as usual. Turn to page 46 to continue entering your treatment values or, if already entered, turn to page 86 to begin your treatment.



Note: Do not remove the IQdrive until your treatment is complete. If the device is removed early, your data cannot be saved to the IQdrive. You may keep the IQdrive in your cyclor until your healthcare staff asks you to bring it back.

Note: If you choose to reject the IQdrive prescription, you will have to reject it for every treatment until you insert an IQdrive with an updated prescription. Contact your PD nurse if you need to update your prescription on your IQdrive.

Moving Your Liberty Cycler

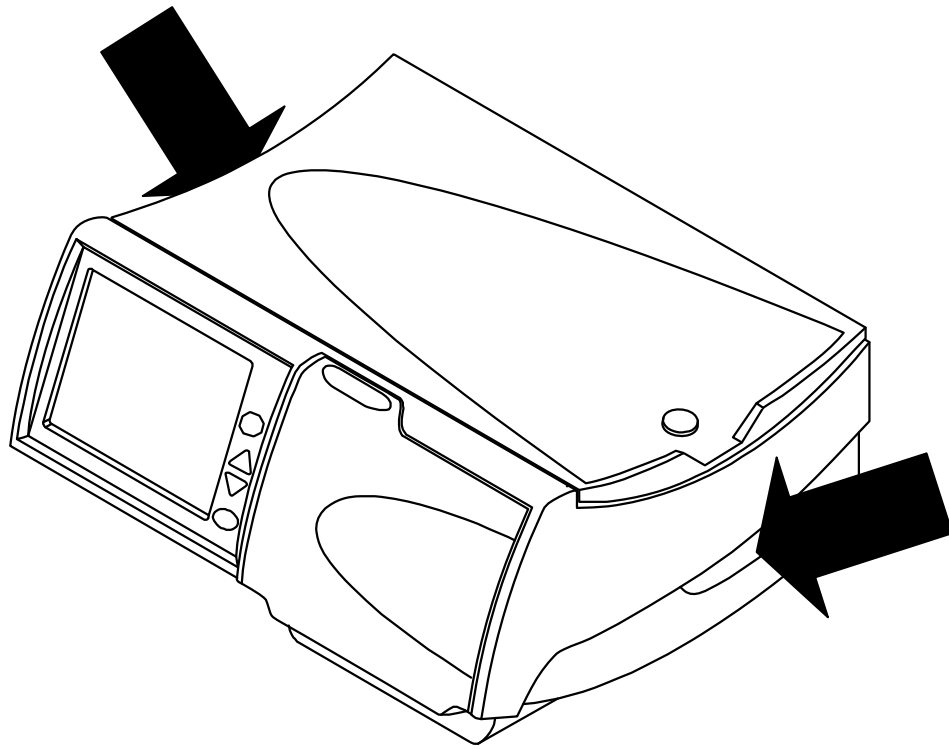

Moving your Liberty cycler

Your Liberty cycler is designed to be portable so you may easily continue your dialysis therapy when you travel.

Unplug your cycler's power cord from the unit before moving it. Hold your cycler by its handles on either side when lifting it.



Warning: Use proper lifting techniques: lift with your knees and not your back.



Caution: Do not lift your machine by the heater tray/scale. Doing this may damage the scale.



Caution: If you are using the Liberty cart, be sure to properly balance the solution bags by hanging them on both sides of the cart. Unbalanced bags on the cart may cause it to tip over and damage your machine. Make sure that you set the cart brakes to OFF when moving the cart and ON when the cart is stationary.



Note: It is recommended that you pack your cycler in its shipping box when you travel outside of your home. Use the original packing material to protect your cycler when it is in the box.

This Page is Intentionally Blank

Alarms & Troubleshooting

Warnings and Alarms

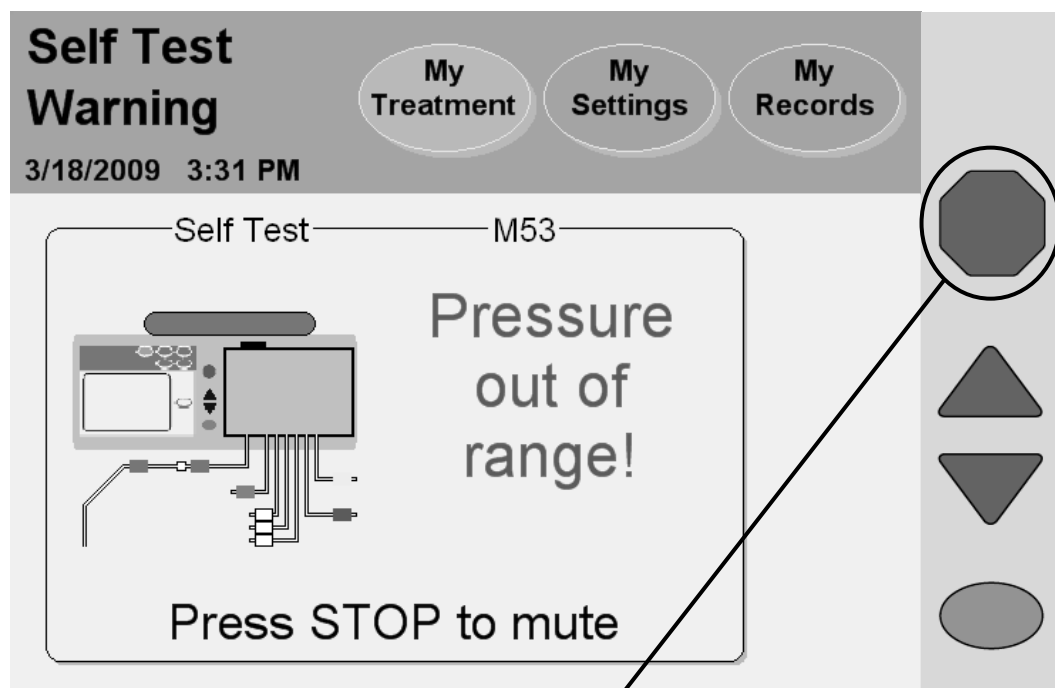

Press STOP key to silence alarm

Warnings and Alarms Overview

Your Liberty cyclor has an advanced system of features that work for your safety. Electronic sensors and diagnostic software constantly monitor your machine's operation. When problems or possible problems are detected, your machine warns you with Status Bar messages and, in some cases, audible alarms.



Warning: All warnings and alarms need your immediate attention. Failure to do so could result in complications that may be severe.

Warnings

During a warning the Status Bar turns orange and an audible alarm sounds. Press the **STOP** key to silence your cyclor. With some warnings, pressing the **OK** key will start a retest and may clear the condition causing the alarm. If available, a **Help** button will appear in the button area (see “Warning: The Help Button” on page 174). You then have the chance to correct the situation by following on-screen instructions. After the problem is corrected, you may continue with your treatment. There are ten different types of warnings:

Heater Warning

The heater temperature is reading too high or too low.

Patient Sensor Warning

The patient sensor is reading incorrectly or is out of range.

Pneumatic Warning

The pneumatic sensor is reading incorrectly or is out of range.

Scale Warning

The scale is reading incorrectly or there is a mismatch in volume pumped versus scale change.

Self Test Warning

A self test has failed but may still be retried.

Sensor Warning

The sensors are reading incorrectly.

(continued)

Warnings and Alarms continued

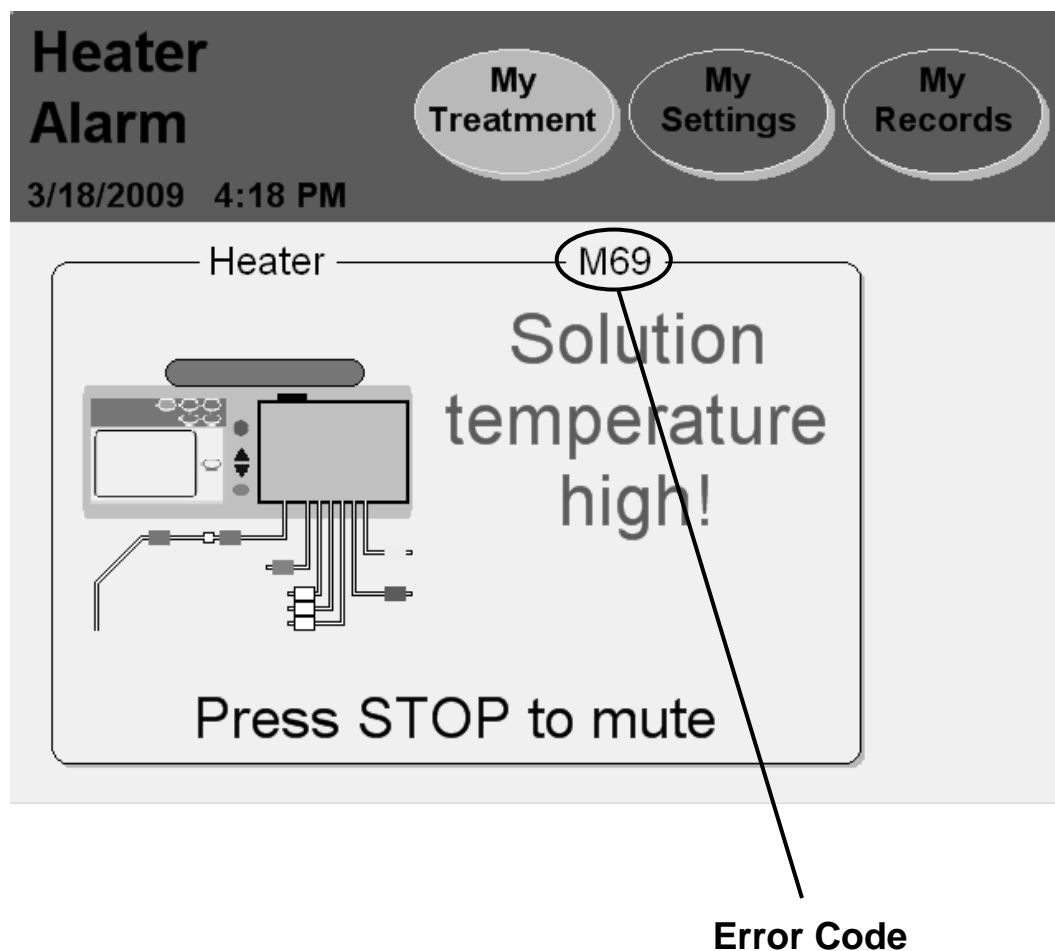

(continued)

Switch Warning

The door or cassette switches are reading incorrectly.

Stopped Warning

You have stopped a function longer than ten minutes. You must press the **STOP** key to silence the alarm and then press the **OK** key to continue if necessary.

System Warning

An error has occurred in the system.

Treatment Warning

A resettable error relating to your treatment has occurred.

Alarms

During an alarm, the Status Bar background turns bright red and an audible alarm sounds. Press the **STOP** key to silence your cyclor. Record the error code and call a qualified technician. The following are alarms:

Battery RAM Alarm

Your cyclor cannot access battery RAM.

CRC Alarm

A critical software error has occurred.

EEPROM Alarm

A critical circuit board error has occurred.

Self Test Alarm

A self test has failed after repeated retests.

System Error

A critical error has occurred.

Treatment Alarm

A Treatment Warning was not able to be corrected.

Watchdog Alarm

A critical software error has occurred.

Warning: The Help Button

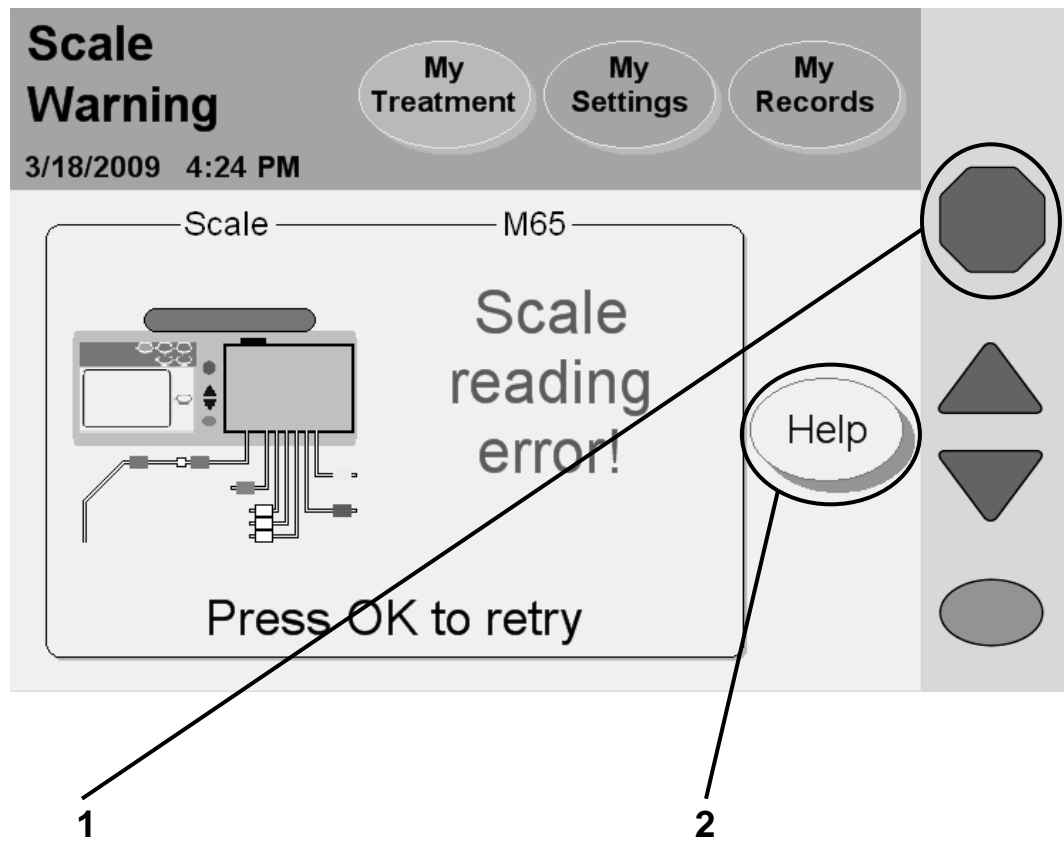

1 Press **STOP**

Press the **STOP** key to silence an audible warning or alarm. If available, a **Help** button will appear in the button area.

2 Touch **Help**

During a warning, your machine may offer a **Help** button to help solve some problems. If you need more information during an alarm, touch the **Help** button.

Warning messages are triggered by conditions and events that occur in your machine during operation. The running function will stop during a warning situation. The messages will reset when the condition causing them is corrected. In some cases, you must reset them yourself.



Note: During an alarm or warning, all the screen-buttons in the Status Bar are unavailable.

Note: For more information on correcting alarms, see “Troubleshooting,” page 180.

Warning: Help Screens

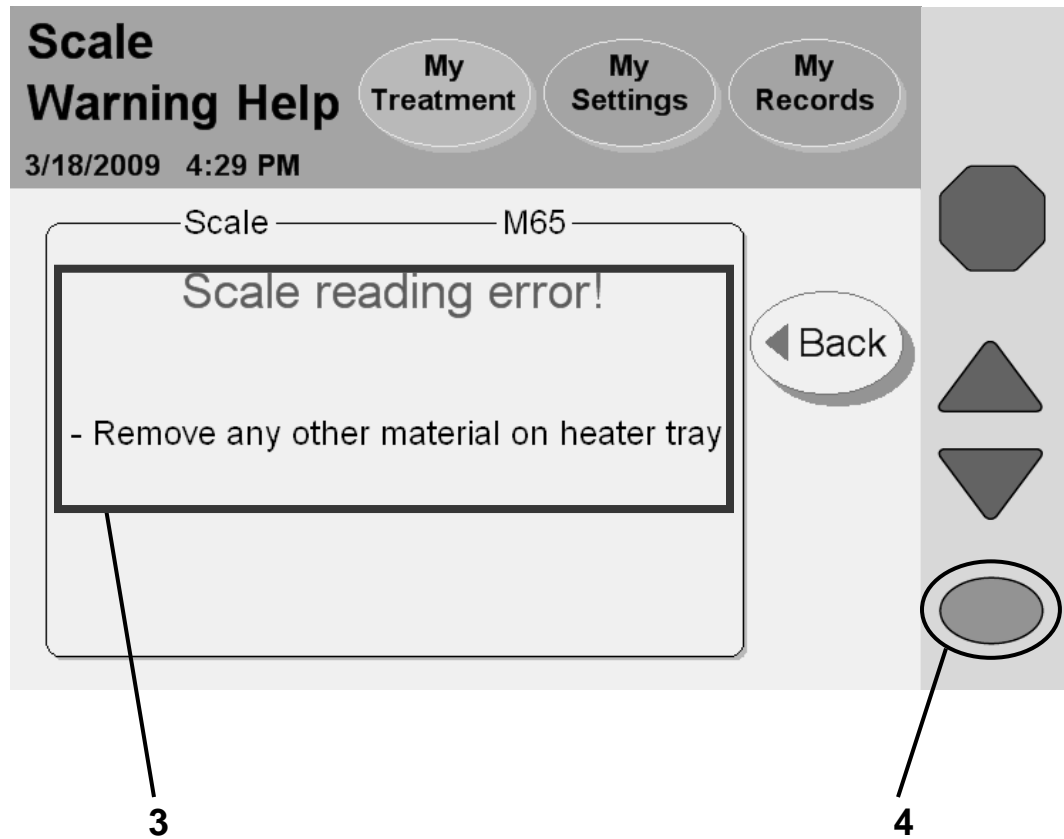

3 Follow steps

Your machine displays specific instructions for each warning. Follow the steps on the screen to correct a warning situation. If you are unable to clear a warning by following the instructions on the screen and in this user's guide, take your machine out of service and call technical support.



Warning: Do not continue your treatment until the warning situation has been corrected.

4 Press **OK**

When you have corrected the warning situation, press the **OK** key (or **Back** first, then **OK**) to resume the function. You will return to the last step you were on before the warning occurred.

Alarm: Red Status Bar

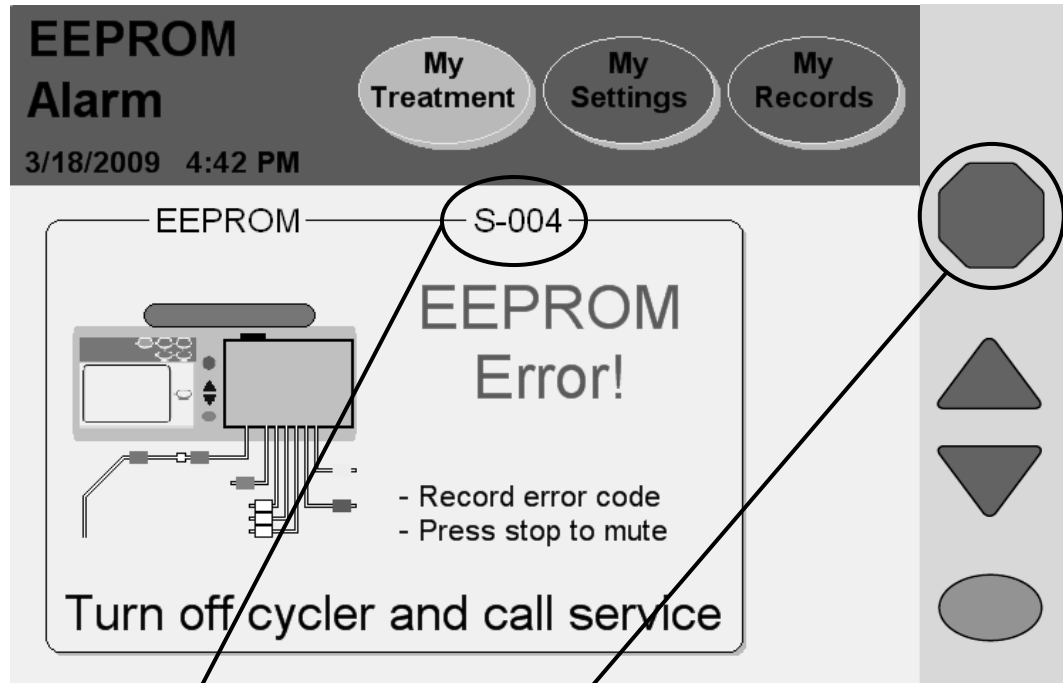

Record Error Code

Press STOP to mute

Turn power OFF

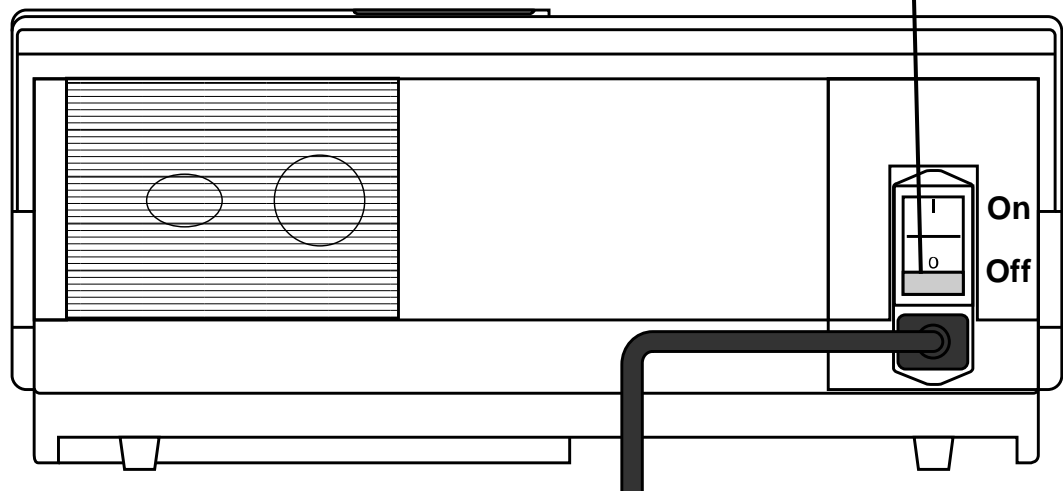

Alarm

During an alarm, the Status Bar turns bright red. Alarms are not resettable. Record the error code (located on the right side just below the Status Bar) and turn your machine off using the power switch on the back. Call Technical Support at (800) 227-2572.



Warning: If your machine alarms, do not attempt to use it for treatment.

You will also be asked for your Liberty cyclor serial number and software version, which is found on the top of your cyclor above the cassette door.

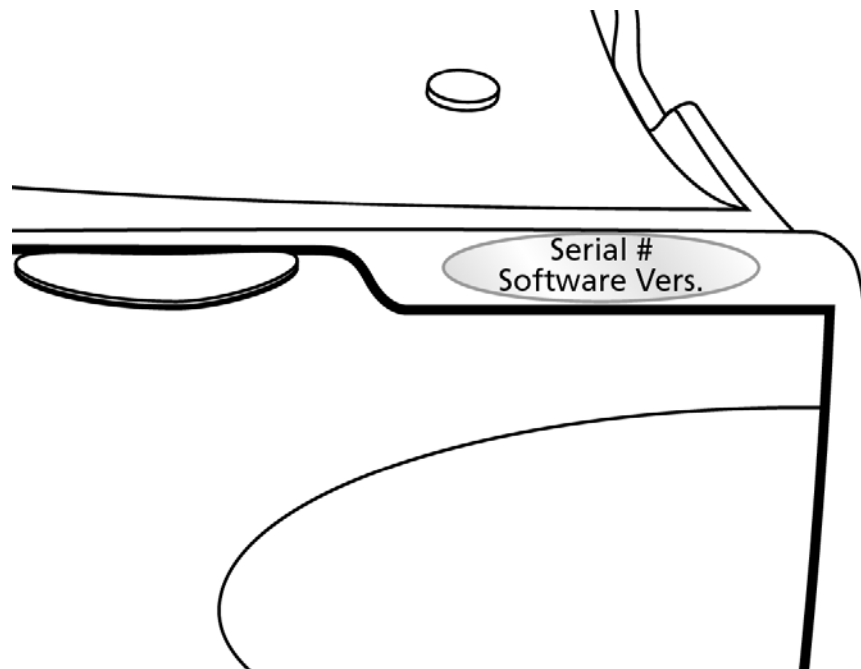

Troubleshooting

The troubleshooting section is a guide to help you troubleshoot machine alarms and messages quickly. These messages are caused by conditions and events that occur in your machine during operation. The messages will reset when the condition causing them is corrected. Some conditions may be reset simply by pressing the **OK** key when prompted. In some cases, you must correct the errors yourself. Alarms in which the Status Bar turns red cannot be resolved; you must call technical support.



Warning: Doing the recommended action may or may not clear the alarm or warning. Do not continue your treatment until the conditions causing these messages are corrected and the messages are cleared.



Note: Refer to the “General Warnings” section, on page 16, for additional warnings.

Note: When your cyclor displays the message “Press the OK key to retry,” try it at least three (3) times before calling your PD nurse or Technical Support.

Note: Machines taken out of service should be tested and repaired by a qualified technician.

There are two tables that list the meaning of the messages and how the error can be resolved. The first table (page 181) lists every error code and the corresponding alarm or warning message. The second table (page 187) lists all messages in alphabetical order.

Be sure to record the error code so you may look up the alarm message. If you call technical support, they will also need this code. The error code is located below the **My Treatment** button:

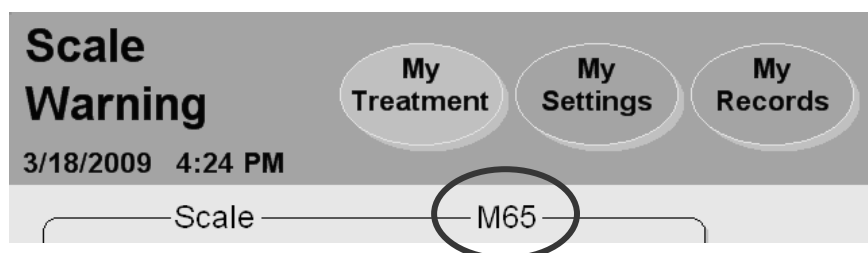

Error messages listed by code

Code	Message	Meaning	Action Required
M19	Switch Warning: Door or Cassette not detected!	The cyclor is unable to detect either the presence of a cassette or a closed door.	Insert the cassette and close the door. Press the OK key to retry.
M21	Sensor Warning: Invalid sensor readings!	A sensor is reading incorrectly.	Press the OK key to retry.
M22	Self Test Alarm: Safety Clamp Error!	The safety clamp test has failed three times.	Record error code. Insert pin. Clamp lines. Disconnect from cyclor. Turn off cyclor and call service.
M30	Self Test Warning: Balloon Valve leak!	The self test has failed due to a possible balloon valve leak during setup.	Press the OK key to retry.
M30.1	Alarm: Balloon Valve leak!	The self test has failed due to a possible balloon valve leak during treatment.	Record error code. Insert pin. Clamp lines. Disconnect from cyclor. Turn off cyclor and call service.
M31	Self Test Warning: Air detected in cassette!	The self test failed due to possible air detection in cassette	Press the OK key to retry.
M37	Self Test Warning: Patient pressure not constant!	The self test has failed due to a changing patient pressure.	Press the OK key to retry.
M38	Treatment Alarm: Treatment data error!	An unrecoverable error has occurred.	Record error code. Insert pin. Clamp lines. Disconnect from cyclor. Turn off cyclor and call service.

Code	Message	Meaning	Action Required
M39	Patient Sensor Warning: Patient sensors against vacuum sensors!	Patient sensor error.	Press the OK key to retry.
M41	Patient Sensor Warning: Patient sensors too high!	Patient sensor error.	Press the OK key to retry.
M42	Patient Sensor Warning: Patient vacuum too high!	Patient sensor error.	Press the OK key to retry.
M44	Treatment Alarm: Flowpath error!	An unrecoverable error has occurred.	Record error code. Insert pin. Clamp lines. Disconnect from cyclor. Turn off cyclor and call service.
M53	Self Test Warning: Pressure out of range!	The self test has failed due to pressures being out of range.	Press the OK key to retry.
M54	Pneumatic Warning: Pressure reading low!	The cyclor's pneumatic pressure is reading too low.	Press the OK key to retry.
M55	Pneumatic Warning: Pressure reading high!	The cyclor's pneumatic pressure is reading too high.	Press the OK key to retry.
M56	Pneumatic Warning: Vacuum reading low!	The cyclor is reading low vacuum pressure.	Press the OK key to retry.
M57	Pneumatic Warning: Vacuum reading high!	The cyclor's vacuum pressure is reading too high.	Press the OK key to retry.
M58	Self Test Warning: Vacuum out of range!	The self test has failed due to vacuum pressures being out of range.	Press the OK key to retry.
M59	Self Test Warning: Pressure leak!	A pressure leak has been detected and the cyclor cannot recover.	Press the OK key to retry.

Code	Message	Meaning	Action Required
M60	Self Test Warning: Vacuum leak!	The self test has failed due to a possible vacuum leak.	Press the OK key to retry.
M61	Self Test Warning: Pressure production low!	The self test has failed due to low pressures.	Press the OK key to retry.
M62	Self Test Warning: Vacuum production low!	The self test has failed due to low vacuum pressures.	Press the OK key to retry.
M63	Self Test Warning: Remove Heater Bag from Heater Tray	The self test detects a heater bag on the heater tray when not expected.	Press the OK key to retry.
M65	Scale Warning: Scale reading error!	Unexpected scale change during treatment	Remove any other material on heater tray. Press the OK key to retry.
M66	Self Test Warning: Thermistor reading out of range!	The self test has failed due to thermistors being out of range	Make sure nothing is on top of heater tray. Make sure cyclor has cooled down. Make sure cyclor is not placed near a heat source. Press the OK key to retry.
M67	Self Test Alarm: Fluid temperature out of range!	The solution temperature test has failed.	Record error code. Insert pin. Clamp lines. Disconnect from cyclor. Turn off cyclor and call service.

Code	Message	Meaning	Action Required
M68	Heater Warning: Heater temperature too high!	The solution temperature test has failed due to high temperatures.	Remove any other material on heater tray. Make sure cyclor is not placed near a heat source. Press the OK key to retry.
M69	Heater Alarm: Solution temperature high!	The solution temperature test has failed three times due to high temperatures.	Record error code. Insert pin. Clamp lines. Disconnect from cyclor. Turn off cyclor and call service.
M70	Heater Warning: Solution temperature low!	The solution temperature test has failed due to low temperatures.	Cold bags will increase warming time, be sure to store your bags at room temperature. Check if heater plate is warm to touch. Check for external cooling sources: Be sure there are no open windows, drafts, or fans or air conditioners blowing Press the OK key to retry.
M71.1	Pneumatic Alarm: Pressure leak!	The self test has failed due to a possible pressure leak.	Record error code. Insert pin. Clamp lines. Disconnect from cyclor. Turn off cyclor and call service.
M71.2	Pneumatic Alarm: Pressure leak!	The self test has failed due to a possible balloon valve leak.	Record error code. Insert pin. Clamp lines. Disconnect from cyclor. Turn off cyclor and call service.

Code	Message	Meaning	Action Required
M71.3	Pneumatic Alarm: Pressure leak!	The self test has failed due to a possible vacuum leak.	Record error code. Insert pin. Clamp lines. Disconnect from cyclor. Turn off cyclor and call service.
M74	Treatment Alarm: Treatment starts error!	An unrecoverable error has occurred.	Record error code. Insert pin. Clamp lines. Disconnect from cyclor. Turn off cyclor and call service.
M75	Treatment Warning: Volume error!	Volume is not being pumped although the pumps are moving	Press the OK key to retry.
M76	Treatment Alarm: Pause time error!	An unrecoverable error has occurred.	Record error code. Insert pin. Clamp lines. Disconnect from cyclor. Turn off cyclor and call service.
M77	Treatment Warning: Encoder flag error!	Treatment error.	Press the OK key to retry.
MWD	Watchdog Alarm: Watchdog timer Error!	An unrecoverable error has occurred.	Record error code. Insert pin. Clamp lines. Disconnect from cyclor. Turn off cyclor and call service.

Code	Message	Meaning	Action Required
S_002	CRC Alarm: CRC Error!	The CRC is corrupted.	Record error code. Insert pin. Clamp lines. Disconnect from cyclor. Turn off cyclor and call service.
S_003	Battery RAM Alarm: Battery RAM Error!	The battery RAM is corrupted.	Record error code. Insert pin. Clamp lines. Disconnect from cyclor. Turn off cyclor and call service.
S_004	EEPROM Alarm: EEPROM Error!	During startup, the cyclor cannot properly read the EEPROM memory chip.	Record error code. Insert pin. Clamp lines. Disconnect from cyclor. Turn off cyclor and call service.
S_005	System Error	An unrecoverable error has occurred.	Record error code. Insert pin. Clamp lines. Disconnect from cyclor. Turn off cyclor and call service.
S_006	System Warning	An unexpected error has occurred.	Press the OK key to retry.

Error messages listed alphabetically

Message	Meaning	Action Required
Battery RAM Alarm: Battery RAM Error!	The battery RAM is corrupted.	Record error code. Insert pin. Clamp lines. Disconnect from cyclor. Turn off cyclor and call service.
bypass not allowed!	The operator has tried to bypass the current exchange.	None required. You cannot bypass while the heater bag is filling. If your cyclor detects that an overfill situation could occur (150% = next Fill + amount not drained from previous Fills), you cannot bypass and the machine will continue to attempt to drain you until it is safe to move on to the next Fill.
CRC Alarm: CRC Error!	The CRC is corrupted.	Record error code. Insert pin. Clamp lines. Disconnect from cyclor. Turn off cyclor and call service.
Drain complication encountered. Please check patient and drain lines.	Your cyclor checks halfway through a Drain cycle to see if you have drained at least 35% of your expected drain volume. If not, your cyclor will beep to alert you of a low drain rate. If you still haven't drained at least 70% of your previous Fill by the end of the Drain, your cyclor will alert you again that you are having drain complications.	Check the Drain Line (Yellow clamp) is not kinked, bent, or clamped. Check that your blue patient line is not kinked and the clamp is open. Check for fibrin or clots in the drain line. If so, contact your PD nurse for instructions on what to do. Change positions to move fluid within your abdomen. Check that the Drain Line is properly placed in drainage receptacle such as a toilet, sink or bathtub. Check position of drain bags and make sure they are flat and not on top of each other. Are you constipated? If so, contact your PD nurse for instructions on what to do. Check that your catheter/ extension set is adequately secured.

Message	Meaning	Action Required
Drain Line is blocked. Please check the drain line.	Your cyclor is having trouble pumping used dialysate to the drain.	Make sure that the Drain Line (Yellow clamp) is properly connected, the clamps are open and there is no kink in the line. Press the OK key to retry.
EEPROM Alarm: EEPROM Error!	During startup, the cyclor cannot properly read the EEPROM memory chip.	Record error code. Insert pin. Clamp lines. Disconnect from cyclor. Turn off cyclor and call service.
Fill complication encountered. Please check heater, patient, and drain lines.	Your cyclor is having trouble pumping dialysate to you.	Make sure that the Heater Bag Line (Red clamp) is properly connected, the clamps are open and there is no kink in the line. Make sure that the Heater Bag is properly positioned on the Heater Tray (see page 94). Make sure that the blue patient line is properly connected, the clamps are open and there is no kink in the line. Make sure that the Drain Line (Yellow clamp) is properly connected, the clamps are open and there is no kink in the line. Press the OK key to retry.
Heater Alarm: Solution temperature high!	The solution temperature test has failed three times due to high temperatures.	Record error code. Insert pin. Clamp lines. Disconnect from cyclor. Turn off cyclor and call service.
Heater Warning: Heater temperature too high!	The solution temperature test has failed due to high temperatures.	Remove any other material on heater tray. Make sure cyclor is not placed near a heat source. Press the OK key to retry.
Heater Warning: Solution temperature low!	The solution temperature test has failed due to low temperatures.	Cold bags will increase warming time, be sure to store your bags at room temperature. Check if heater plate is warm to touch. Check for external cooling sources: Be sure there are no open windows, drafts, or fans or air conditioners blowing. Press the OK key to retry.

Message	Meaning	Action Required
IQdrive not detected	The IQdrive is either not inserted or not inserted correctly.	Remove the IQdrive and firmly re-insert it to try again. Or press the OK key to ignore the message and continue without using the IQdrive.
IQdrive Port Error	Your cycler cannot access the IQdrive.	Turn off cycler, wait 10 seconds, and turn it back on again. If the message is not cleared, call service.
Make sure the heater bag is on the heater tray and the line is not clamped.	Your cycler is having trouble pumping dialysate from the heater bag.	Make sure that the Heater Bag Line (Red clamp) is properly connected, the clamps are open and there is no kink in the line. Make sure that the Heater Bag is properly positioned on the Heater Tray (see page 94) and the cone is broken. Press the OK key to retry.
Patient line is blocked. Please check the patient line.	Your cycler is having trouble pumping dialysate into your body.	Make sure that the blue patient line is properly connected, the clamps are open and there is no kink in the line. Press the OK key to retry.
Patient Sensor Warning: Patient sensors against vacuum sensors!	Patient sensor error.	Press the OK key to retry.
Patient Sensor Warning: Patient sensors too high!	Patient sensor error.	Press the OK key to retry.
Patient Sensor Warning: Patient vacuum too high!	Patient sensor error.	Press the OK key to retry.
Please do not insert cassette now. Close Cassette Door.	The cassette is inserted in your cycler before your treatment has started. Or your cassette door is open when it should be closed.	If the cassette is inserted in your cycler, remove the cassette and close the door. Make sure the door is closed securely. Press the OK key to retry.

Message	Meaning	Action Required
Please wait for solution to cool down	The Drain phase is finished but the heater bag solution temperature is above 38°C. The cyclor will not allow Fill to begin until the the temperature drops below 38°C.	Wait for the heater bag temperature to decrease. If this message occurs frequently, check for external heating sources and make sure that the room temperature is cooler than 100°F (38°C).
Please wait for solution to warm up	The Drain phase is finished but the heater bag solution temperature is still below 25°C. The cyclor will not allow Fill to begin until the the temperature reaches 33°C.	Wait for the heater bag temperature to increase. If this message occurs frequently, check for external cooling sources: Be sure there are no open windows, drafts, or fans or air conditioners blowing on your cyclor.
Pneumatic Alarm: Balloon Valve Leak!	The self test has failed due to a possible balloon valve leak during treatment.	Record error code. Insert pin. Clamp lines. Disconnect from cyclor. Turn off cyclor and call service.
Pneumatic Alarm: Pressure leak!	A pressure leak has been detected and the cyclor cannot recover.	Record error code. Insert pin. Clamp lines. Disconnect from cyclor. Turn off cyclor and call service.
Pneumatic Warning: Pressure reading high!	The cyclor's pneumatic pressure is reading too high.	Press the OK key to retry.
Pneumatic Warning: Pressure reading low!	The cyclor's pneumatic pressure is reading too low.	Press the OK key to retry.
Pneumatic Warning: Vacuum reading high!	The cyclor's vacuum pressure is reading too high.	Press the OK key to retry.
Pneumatic Warning: Vacuum reading low!	The cyclor is reading low vacuum pressure.	Press the OK key to retry.

Message	Meaning	Action Required
Press OK key to start fill...	The solution temperature is cool (25°C/77°F). The user must choose whether or not to wait for it to reach the set temperature.	To continue Fill with cool solution, press the OK key; otherwise, wait until your solution has reached the set temperature to continue. When the set temperature has been reached, it will automatically start the Fill.
Scale Warning: Scale reading error!	The heater bag on the scale is not within allowable limits.	Remove any other material on heater tray. Press the OK key to retry.
Self Test Alarm: Fluid temperature out of range!	The solution temperature test has failed three times.	Record error code. Insert pin. Clamp lines. Disconnect from cyclor. Turn off cyclor and call service.
Self Test Alarm: Safety Clamp Error!	The safety clamp test has failed three times.	Record error code. Insert pin. Clamp lines. Disconnect from cyclor. Turn off cyclor and call service.
Self Test Warning: Air detected in cassette!	The self test failed due to possible air detection in cassette	Press the OK key to retry.
Self Test Warning: Balloon Valve leak!	The self test has failed due to a possible balloon valve leak.	Press the OK key to retry.
Self Test Warning: Patient pressure not constant!	The self test has failed due to a changing patient pressure.	Press the OK key to retry.
Self Test Warning: Pressure leak!	The self test has failed due to a possible pressure leak.	Press the OK key to retry.
Self Test Warning: Pressure out of range!	The self test has failed due to pressures being out of range.	Press the OK key to retry.
Self Test Warning: Pressure production low!	The self test has failed due to low pressures.	Press the OK key to retry.

Message	Meaning	Action Required
Self Test Warning: Remove Heater Bag from Heater Tray	The self test detects a heater bag on the heater tray when not expected.	Press the OK key to retry.
Self Test Warning: Thermistor reading out of range!	The self test has failed due to a temperature sensor reading too hot.	Make sure nothing is on top of heater tray. Make sure cyclor has cooled down. Make sure cyclor is not placed near a heat source. Press the OK key to retry.
Self Test Warning: Vacuum leak!	The self test has failed due to a possible vacuum leak.	Press the OK key to retry.
Self Test Warning: Vacuum out of range!	The self test has failed due to vacuum pressures being out of range.	Press the OK key to retry.
Self Test Warning: Vacuum production low!	The self test has failed due to low vacuum pressures.	Press the OK key to retry.
Sensor Warning: Invalid sensor readings!	A sensor is reading incorrectly.	Press the OK key to retry.
Supply Lines are blocked. Please check the supply lines.	Your cyclor is having trouble pumping out of the solution bags.	Make sure that the solution lines (White and Green clamps) are properly connected, the clamps are open and there is no kink in the lines. Make sure the cones are all broken. Make sure that the bags are not empty. Press the OK key to retry.
Switch Warning: Door or Cassette not detected!	The cyclor is unable to detect either the presence of a cassette or a closed door.	Insert the cassette and close the door. Press the OK key to retry.
System Error	An unrecoverable error has occurred.	Record error code. Insert pin. Clamp lines. Disconnect from cyclor. Turn off cyclor and call service.

Message	Meaning	Action Required
System Warning	An unexpected error has occurred.	Press the OK key to retry.
Treatment Alarm: Flowpath error!	An unrecoverable error has occurred.	Record error code. Insert pin. Clamp lines. Disconnect from cyclor. Turn off cyclor and call service.
Treatment Alarm: Pause time error!	An unrecoverable error has occurred.	Record error code. Insert pin. Clamp lines. Disconnect from cyclor. Turn off cyclor and call service.
Treatment Alarm: Treatment data error!	An unrecoverable error has occurred.	Record error code. Insert pin. Clamp lines. Disconnect from cyclor. Turn off cyclor and call service.
Treatment Alarm: Treatment starts error!	An unrecoverable error has occurred.	Record error code. Insert pin. Clamp lines. Disconnect from cyclor. Turn off cyclor and call service.
Treatment Warning: Volume error!	Volume is not being pumped although the pumps are moving.	Press the OK key to retry.
Treatment Warning: Encoder flag error!	Treatment error.	Press the OK key to retry.
Watchdog Alarm: Watchdog timer Error!	An unrecoverable error has occurred.	Record error code. Insert pin. Clamp lines. Disconnect from cyclor. Turn off cyclor and call service.

Different People Drain Differently

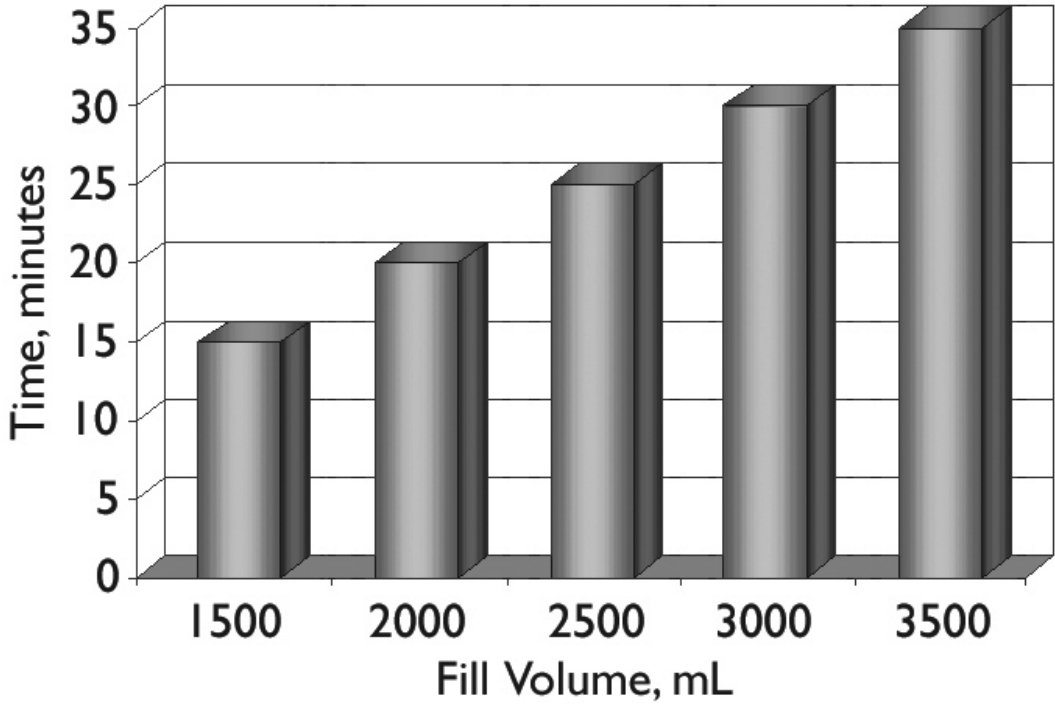

Different People Drain Differently

The way your body and your PD catheter respond to your pumping cyclor may be different. If you've already been doing dialysis as CAPD or on another type of cyclor, the amount of time that you need to drain may not be the same as before. Your Liberty cyclor is designed to drain at a rate of 100 mL per minute for most Drain cycles. This means that if you program your cyclor to drain your peritoneal cavity in a shorter time, the rate would have to be faster and you may have problems with drain alarms.

To help eliminate drain alarms, you and your PD Nurse should program your Drain Time to correspond with the amount of fluid you have filled. The graph to the left shows the amount of time in minutes to program into your cyclor for your drain times depending on the fill volume that you use.

According to this graph for example, if you have filled with 2000 mL of fluid, you will need 20 minutes to drain.

Power Failure

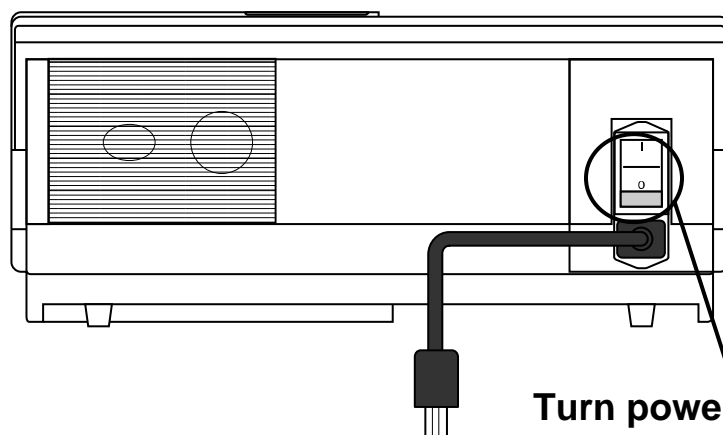
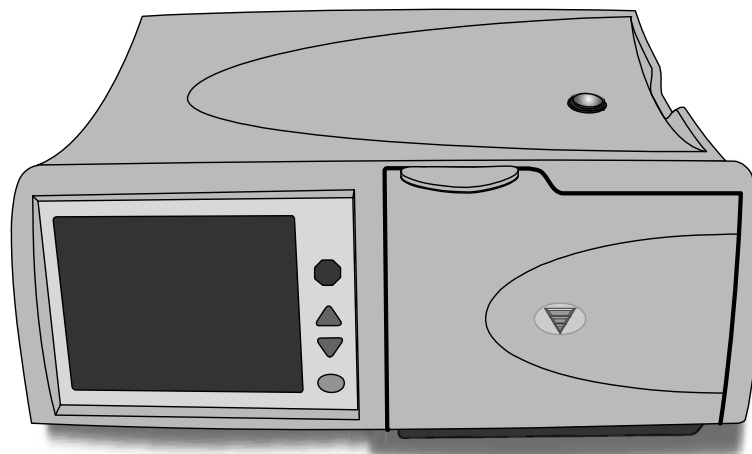

Turn power back ON

Power failure

During a power failure (or if the power switch was turned off), all valves close, the pump stops, and the Touch Screen goes blank.



Note: If the power failure occurs during a Drain, Fill, Dwell, or Pause, your cyclor will keep track of your current location and progress.

You may still continue your same treatment if the power returns within eight hours. Depending on how long the power failure lasts, you may wish to disconnect from your cyclor.

To disconnect from your cyclor:

- Push in the pin—twist the pin $\frac{1}{4}$ turn and then push it in to make sure that a new pin is inserted in the line
- Close blue patient line clamp
- Close catheter extension clamp
- Carefully disconnect the patient line from your extension set and cap off with a new sterile stay•safe cap

Power restored

When the power is restored to your cyclor, turn the Power Switch on the back of your machine ON if it is not already on. Your machine will then go through a series of self-tests before you may choose whether or not to continue with your treatment.

(continued)

Power Failure continued

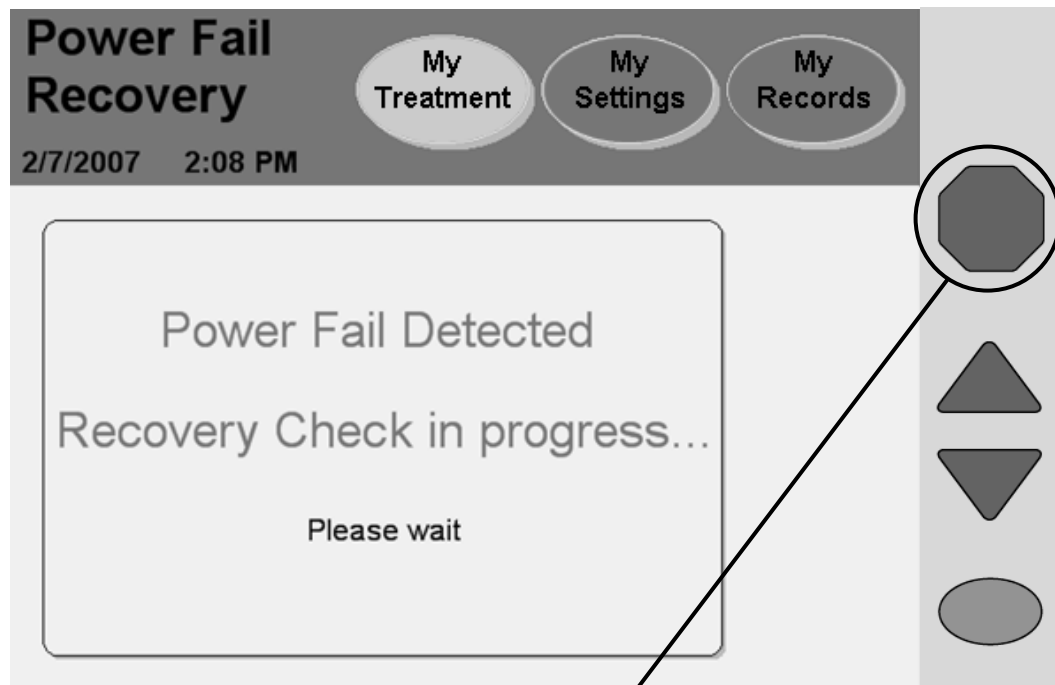

Press **STOP** to mute

(continued)

Press **STOP**

Press the **STOP** key to silence the audible warning. Your cyclor will perform a safety systems check. If the Power Fail Recovery is successful, your machine will beep again. Press the **STOP** key to silence the alarm again. Then you may select the **Resume Treatment** button to continue your Drain, Fill, Dwell, or Pause where you left off.

Follow your PD nurse's power failure instructions to reconnect to your machine if you have disconnected. If you are instructed to, you may continue with your treatment.



Note: The letter 'F' will be displayed next to your treatment details in the "My Records" screen to show a power failure occurred during that treatment. For more information, see "Treatment Details" on page 151.

Recovery failure

If the Power Fail Recovery test fails, you must select the **Cancel Treatment** button and start a new treatment.

Follow the instructions on the screen:

- Push in the pin—twist the pin ¼ turn and then push it in to make sure that a new pin is inserted in the line.
- Close blue patient line clamp
- Close catheter clamp
- Use aseptic technique to carefully disconnect the patient line from your extension set and cap off with a new sterile stay•safe cap.
- Check that your catheter/extension set is firmly anchored in place
- Press the **Next** button to continue
- Close all clamps
- When prompted, open the door and remove the cassette
- Restart your entire treatment with fresh dialysate bags and a new cassette



Note: If your power failure lasts longer than eight hours, you may not resume your treatment.

This Page is Intentionally Blank

Cleaning, Specifications, Index, and Glossary

Cleaning Your Cyclor

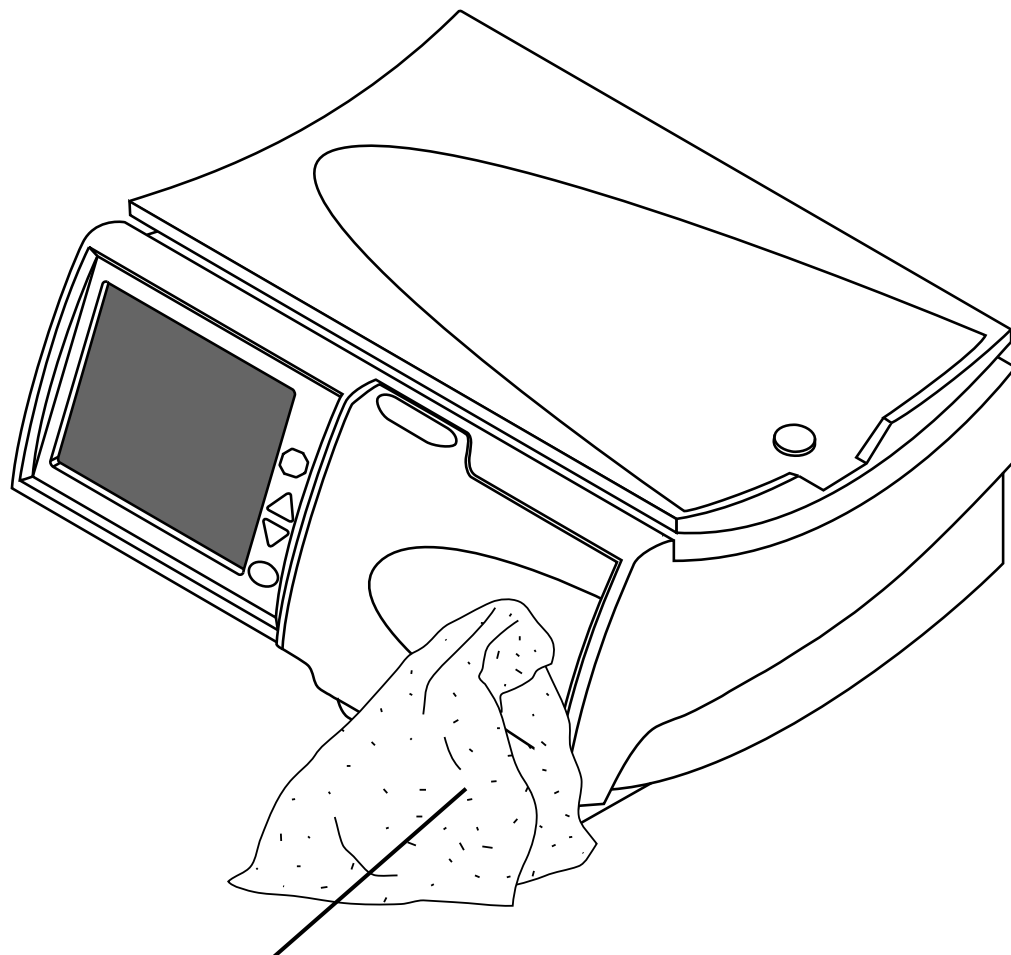

Damp Cloth

Cleaning your cyclor

The Liberty cyclor is not sterile equipment, however, you should keep your Liberty cyclor clean and dry at all times. Clean the exterior surface of your machine as needed using a damp cloth and a dilute (1:100) bleach solution or other suitable hospital disinfectant.

Use surface cleaner in small amounts to avoid excess cleaner from entering the interior of your machine. Rinse off cleaning solutions with a water-dampened cloth, especially if a corrosive cleaner such as bleach is used.

If you need to clean your stay•safe organizer, you may wash it with warm soapy water or place it in the top rack of your dishwasher.



Caution: Do not allow any fluid to drip into your cyclor or onto the pump module. The cyclor must be OFF when you are cleaning it to prevent fluid from entering the pump module. If any fluid gets inside your cyclor, you must contact Technical Support immediately. Clean fluid spills immediately to prevent moisture from possibly damaging your machine. Your machine should be placed on a water-tolerant surface, and spills should be cleaned up immediately.

Caution: Do not touch the white pressure sensors in the pump module. Pressing on the pressure sensors may damage them.

Caution: Do not use foaming type cleansers or disinfectants containing alcohol or quaternary ammonium compounds like N-alkyl (C12-C18) dimethyl benzyl ammonium chloride. These chemicals attack the polycarbonate plastics used in your machine. Read the product labels and follow the instructions. Do not use spray bottles.

Periodically check your Liberty cyclor for:

- Damage to the cabinet
- Loose or missing pieces

There is no other preventative maintenance for your cyclor.

Any service must be performed by an FMCNA service technician. If your cyclor needs service, call Technical Support at **(800) 227-2572**.

Machine Specifications

Overall

Dimensions 21.5 cm H x 41.28 cm D x 47.63 cm W

Weight Approximately 14.5 kg (32 lbs.)

Operating Conditions

Temperature 15-37°C (59 – 98°F)

Rel. Humidity 30-75% (EN 60601-1-2)

Atmospheric Pressure Range 80 kPa to 106 kPa

Noise Level Does not exceed 40 dBA

Transportation and Storage Conditions

Temperature -31 to 54°C (-25 to 130 °F) 6 months

Rel. Humidity Non-condensing

Atmospheric Pressure Range 50 kPa to 106 kPa

Electrical

Power Supply Single phase or two phase center-tapped
AC 100-240 V, 50/60Hz

Power consumption 480 Watts at 100V
700 Watts at 240V

Circuit Breaker 6 Amp. breaker contained in Power Entry Module

External Connections USB Port

IEC 60601-1:1988, A1:1991, A2:1995

Clause 6.8.2a, 6.8.2c (Accessories, SIP/SOP connections)

Accessories equipment connected to the analog and digital interfaces must be certified to the respective IEC standards (i.e. IEC 60950 for data processing equipment and IEC 60601-1 for medical equipment). Furthermore all configurations shall comply with the system standard IEC 60601-1-1. Persons who connect additional equipment to the signal input part or signal output part configure a medical system, and are therefore responsible that the system complies with the requirements of the system standard IEC 60601-1-1. If in doubt, consult the technical support department or your local representative.

Electro- See EMC Declaration on page 207
magnetic
compatibility

Electrical Safety (UL 60601-1)

Protection against electric shock Type: Class I equipment
Degree: Type BF Applied Part

IP Rating IPX0. Meets the requirements of IEC 60601-2-39 (Clause 44.3) regarding degree of protection against ingress of water.

Mode of Operation Continuous Operation

Equipment not suitable for use in the presence of a flammable anesthetic mixture with air or with oxygen or nitrous oxide.

User Interface

Language The operating screens may be set to either English (USA), French (Canada), or Spanish (Mexico)

Touch Screen LCD display reacts to fingertip pressure

Keys Up ▲, Down ▼, STOP, OK

Hardware Settings

Alarm Loudness 1-20 (50-90 dB)

Key Loudness 0-20

Screen Blank- ing Delay 10 minutes

Screen Brightness 1-10

Fluid

Bag Sizes 2000, 3000, 5000 mL

Initial Fill Volume Range 500 to 4000 mL

Temperature Fixed at 37°C ±1°C (98.6°F ±1.8°F)
Minimum 15°C bag temperature in order to start treatment

Maximum Total Volume 25,000 mL

Drain Time 1-59 minutes

Fill Volume 500-4000 mL

Pause Volume 0-4000 mL

Last Fill Volume 0-4000 mL

Pressures Generated -250 mbar to 650 mbar (pressures that can be generated to assist the transfer of dialysate solution to and/or from the peritoneal cavity of the patient)

Therapy

Total Therapy Time 10 minutes to 47 hours, 59 minutes

Number of Fills 1-99 (Exchanges)

Dwell Time Variable from 0 minutes to 9 hours, 59 minutes

Pauses Variable from 0 to 1 less than # of Fills

Safety Systems

Air Infusion Protection Controlled by software: cyclor measures air volume in three consecutive strokes coming from source. Any air volume over the set limits (see below) is pumped to drain and M31 (Air Detected in Cassette) warning is displayed.

Air Detector Sensitivity Limits

Fill: air volume coming from heater bag ≥ 3 mL

Drain: air volume coming from patient bag ≥ 3 mL

Dwell: If air volume coming from supply bag ≥ 6 mL

Dialysate Solution Overfill Protection Controlled by software: Drain bypass is prevented when overfill is 1.5 or 150% of prescribed Fill (150% = next Fill + amount of previous Fill not yet Drained)

Over Temperature Protection Over temperature protected by two thermostats opening at $104^{\circ} \pm 4^{\circ}\text{F}$ and $120^{\circ} \pm 4^{\circ}\text{F}$

Options

Add diurnal UF

SI Units

Last bag option

Personal data

> 24 hr tx (disabled in V2.4.7)

USB enabled

Language

Accessories

IQdrive (P/N 365039-13)

Liberty Cart (P/N 180080)



MEDICAL EQUIPMENT

WITH RESPECT TO ELECTRICAL SHOCK, FIRE AND MECHANICAL HAZARDS ONLY
IN ACCORDANCE WITH 60601-1 and 60601-2-39

CAN/CSA – C22.2 No. 601

CAN/CSA – C22.2 No. 601.2.39

Control No. 36CT

Manufacturer's EMC Declaration

The Liberty cyclor has been certified to the requirements of ANSI/AAMI/IEC 60601-1-2 within the scope of equipment intended to be used in the home and institutional environments, such as hospitals.

Emissions testing of the machine was performed using the limits for CISPR 11 Group 1, Class B which are specified for equipment intended to be used in homes. However, use of the Liberty cyclor in residential environments may result in interference with some types of broadcast receivers such as televisions and radios. Should such interference occur, it will not permanently affect those receivers and can be reduced or eliminated by repositioning of the receiver or the Liberty cyclor.

In order to assure the safety of the Liberty cyclor as well as other medical devices when used with the Liberty cyclor in the home environment, a detailed technical analysis was performed. This analysis has shown that the emissions levels of the Liberty cyclor are significantly below the immunity requirements of ANSI/AAMI/IEC 60601-1-2 and therefore are not likely to impact the safe operation of other medical devices used within the proximity.

Guidance and manufacturer's declaration – electromagnetic emissions		
The Liberty cyclor is intended for use in the electromagnetic environment specified below. The customer or user of the Liberty cyclor should ensure it is used in such an environment.		
Emissions test	Compliance	Electromagnetic environment – guidance
RF Emissions CISPR 11	Group 1	The Liberty cyclor uses RF energy only for its internal functions. Therefore, its RF emissions are very low and are not likely to cause any interference in nearby electronic equipment.
RF Emissions CISPR 11	Class B	The Liberty cyclor is suitable for use in all establishments including domestic, and those directly connected to the public low-voltage power supply network that supplies buildings used for domestic purposes.
Harmonic emissions IEC 61000-3-2	N/A	
Voltage fluctuations/ flicker emissions IEC 61000-3-3	N/A	

Guidance and manufacturer's declaration – electromagnetic immunity			
The Liberty cyclor is intended for use in the electromagnetic environment specified below. The customer or the user of the Liberty cyclor should assure that it is used in such an environment.			
Immunity test	IEC 60601 test level	Compliance level	Electromagnetic environment – guidance
Electrostatic discharge (ESD) IEC 61000-4-2	±6 kV contact ±8 kV air	±6 kV contact ±8 kV air	Can be used in a dry location (minimum 30% relative humidity)
Electrical fast transient/burst IEC 61000-4-4	±2 kV for power supply lines ±1 kV for input/output lines	±2 kV for power supply lines ±1 kV for input/output lines	Mains power quality should be that of a typical low-voltage power supply network that supplies hospitals or buildings used for commercial or domestic purposes.
Surge IEC 61000-4-5	±1 kV differential mode ±2 kV common mode	±1 kV differential mode ±2 kV common mode	Mains power quality should be that of a typical low-voltage power supply network that supplies hospitals or buildings used for commercial or domestic purposes.
Voltage Dips, short interruptions, and voltage variation on power supply input lines IEC 61000-4-11	<5 % U_T (>95 % dip in U_T) for 0.5 cycles 40 % U_T (60 % dip in U_T) for 5 cycles 70 % U_T (30 % dip in U_T) for 25 cycles <5 % U_T (>95 % dip in U_T) for 5 seconds	<5 % U_T (>95 % dip in U_T) for 0.5 cycles 40 % U_T (60 % dip in U_T) for 5 cycles 70 % U_T (30 % dip in U_T) for 25 cycles <5 % U_T (>95 % dip in U_T) for 5 seconds	Mains power quality should be that of a typical low-voltage power supply network that supplies hospitals or buildings used for commercial or domestic purposes. If the user of the Liberty cyclor requires continued operation during power mains interruptions, it is recommended that the Liberty cyclor be powered from an uninterruptible power supply.
Power-Frequency (50/60 Hz) magnetic field IEC 61000-4-8	3 A/m	3 A/m	Power frequency magnetic fields should be at levels characteristic of a typical public low-voltage power supply network that supplies hospitals or buildings used for commercial or domestic purposes.
NOTE U_T is the a.c. mains voltage prior to application of the test level.			

Guidance and manufacturer's declaration – electromagnetic immunity			
The Liberty cyclor is intended for use in the electromagnetic environment specified below. The customer or the user of the Liberty cyclor should assure that it is used in such an environment.			
Immunity test	IEC 60601 test level	Compliance level	Electromagnetic environment – guidance
Conducted RF IEC 61000-4-6 Radiated RF IEC 61000-4-3	3 Vrms 150 kHz to 80 MHz 3 V/m 80 MHz to 2.5 GHz	3 Vrms 150 kHz to 80 MHz 3 V/m 80 MHz to 2.5 GHz	<p>Portable and mobile RF communications equipment should be used no closer to any part of the Liberty cyclor, including cables, than the recommended separation distance calculated from the equation applicable to the frequency of the transmitter.</p> <p>Recommended separation distance</p> $d = [3.5 / 3] \sqrt{P}$ $d = [3.5 / 3] \sqrt{P} \text{ 80 MHz to 800 MHz}$ $d = [7 / 3] \sqrt{P} \text{ 800 MHz to 2.5 GHz}$ <p>where P is the maximum output power rating of the transmitter in watts (W) according to the transmitter manufacturer and d is the recommended separation distance in meters (m).</p> <p>Field strengths from fixed RF transmitters, as determined by an electromagnetic site survey,^a should be less than the compliance level in each frequency range.^b</p> <p>Interference may occur in the vicinity of equipment marked with the following symbol: </p>
NOTE 1	At 80 MHz and 800 MHz, the higher frequency applies.		
NOTE 2	These guidelines may not apply in all situations. Electromagnetic propagation is affected by absorption and reflection from structures, objects, and people.		
^a	Field strengths from fixed transmitters, such as base stations for radio (cellular/cordless) telephones and land mobile radios, amateur radio, AM and FM radio broadcast and TV broadcast cannot be predicted theoretically with accuracy. To assess the electromagnetic environment due to fixed RF transmitters, an electromagnetic site survey should be considered. If the measured field strength in the location in which the Liberty cyclor is used exceeds the applicable RF compliance level above, the Liberty cyclor should be observed to verify normal operation. If abnormal performance is observed, additional measures may be necessary, such as re-orienting or relocating the Liberty cyclor.		
^b	Over the frequency range 150 kHz to 80 MHz, field strengths should be less than 3 V/m.		

**Recommended separation distances between
portable and mobile RF communications equipment and the Liberty cycler**

The Liberty cycler is intended for use in an electromagnetic environment in which radiated RF disturbances are controlled. The customer or the user of the Liberty cycler can help prevent electromagnetic interference by maintaining a minimum distance between portable and mobile RF communications equipment (transmitters) and the Liberty cycler as recommended below, according to the maximum output power of the communications equipment.

Rated maximum output power of transmitter (Watts)	Separation distance according to frequency of transmitter (meters)		
	150 kHz to 80 MHz $d = [3.5 / 3] \sqrt{P}$	80 MHz to 800 MHz $d = [3.5 / 3] \sqrt{P}$	800 MHz to 2.5 GHz $d = [7 / 3] \sqrt{P}$
0.01	0.12	0.12	0.23
0.1	0.37	0.37	0.74
1	1.2	1.2	2.3
10	3.7	3.7	7.4
100	12	12	23

For transmitters rated at a maximum output power not listed above, the recommended separation distance d in meters (m) can be estimated using the equation applicable to the frequency of the transmitter, where P is the maximum output power rating of the transmitter in watts (W) according to the transmitter manufacturer.

NOTE 1 At 80 MHz and 800 MHz, the separation distance for the higher frequency applies.

NOTE 2 These guidelines may not apply in all situations. Electromagnetic propagation is affected by absorption and reflection from structures, objects, and people.

Product Improvement Policy

Your Liberty cyclor machine was designed and built to comply with these product specifications. It is the intention of Fresenius Medical Care to continuously improve products, a process that may result in modifications to specifications or equipment produced in the future. Such product improvements shall not incur any obligation to make similar changes or improvements to equipment previously produced. Where possible, improvements will be made available at reasonable prices. Any such improvement shall not be construed as corrections of any deficiency in previously produced equipment.

Warranty

REFURBISHMENT POLICY

It is the policy of Fresenius USA, Inc. to refurbish medical devices so that they meet the same performance specification as new products. Controlled procedures are used and the refurbishment is carried out at the same manufacturing location under the same quality management system as new medical devices.

REPLACEMENT

Fresenius USA, Inc. sells both new and/or refurbished medical devices. Refurbished medical devices meet the same performance specification as new medical devices (see above) and either may be supplied by the company as warranty replacements.

PERITONEAL CYCLERS

Peritoneal cyclers (Liberty® cycler, Newton IQ® cycler, Freedom® cycler, 90/2® Peritoneal cycler) that are rented or leased may be either new or refurbished units. History files on new and refurbished medical devices are maintained by Fresenius USA, Inc. at its Concord, CA manufacturing facility.

Preventive maintenance of peritoneal cyclers is not required. Service is performed at the factory only. Cyclers requiring service or investigation are replaced, generally with refurbished equipment, so that investigation and/or service can be performed at the factory. No user service records are required.

In cases where the Liberty cyclor is sold, SALE of the machine or parts described or referenced herein is expressly conditioned upon the terms and conditions set forth below. Any additional or different terms or conditions set forth by the Purchaser to Fresenius USA, Inc., (herein called “the Company”) shall not be effective or binding, and the terms set forth herein shall not be modified or amended, unless assented to in writing by an authorized official of the Company located in Waltham, Massachusetts.

LIMITED WARRANTY: *The Company warrants to the Purchaser that the equipment delivered is free from defects in material or workmanship for the periods specified below, provided the equipment is used and maintained in accordance with the original manufacturer’s operating instructions:*

A. Mainframe chassis, and electronic components, lamps, etc. shall be warranted for ninety (90) days from the date of initial installation or one hundred and eighty (180) days from the shipment, whichever occurs first.

B. Consumables shall not be warranted.

*The Company will repair or replace, at its option, using new or reconditioned parts and/or assemblies, any parts subject to this warranty which are proven defective in materials or workmanship. Such repair and replacement will be made without cost to the Purchaser, and the Company reserves the right to determine the location at which the repair or replacement will be accomplished. The Warranty does not apply to any equipment which is misused, abused, neglected, tampered with, damaged by accident, flood, fire, or other hazard, subjected to abnormal or unusual electric or fluid stress, improperly installed or operated, or not maintained in accordance with the routine maintenance schedule set forth in the operating manual for the equipment. **Routine maintenance is not covered under warranty.** Modifications, alterations, installation, and service by other than a FRESSENIUS MEDICAL CARE authorized representative may void the warranty.*

WARRANTIES APPLICABLE TO EQUIPMENT EXTEND ONLY TO THE PURCHASER, AND ARE NOT ASSIGNABLE OR TRANSFERABLE, AND SHALL NOT APPLY TO AUXILIARY EQUIPMENT, DISPOSABLE ACCESSORIES, OR LIGHT SOURCES. THE FOREGOING WARRANTY SHALL BE IN LIEU OF ANY OTHER WARRANTIES, EXPRESSED, IMPLIED, OR STATUTORY, RESPECTING THE EQUIPMENT OR ANY PARTS OR COMPONENTS THEREOF, AND THE COMPANY MAKES NO IMPLIED WARRANTY OF MERCHANTABILITY OR FITNESS FOR A PARTICULAR PURPOSE. THE PURCHASER'S SOLE AND EXCLUSIVE REMEDY IN CONTRACT, TORT, OR UNDER ANY OTHER THEORY AGAINST THE COMPANY RESPECTING THE EQUIPMENT AND ITS USE SHALL BE THE REPLACEMENT OR REPAIR OF THE EQUIPMENT AND ITS PARTS AS DESCRIBED ABOVE, AND NO OTHER REMEDY (INCLUDING, WITHOUT LIMITATION, CONSEQUENTIAL DAMAGES) SHALL BE AVAILABLE TO THE PURCHASER. The Company shall have no further obligation or liability with respect to the equipment or its sale, operation and use, and the Company neither assumes, nor authorizes the assumption of, any obligation or liability in connection with such equipment.

TERMS: *Net 30 days, FOB shipping point plus sales and similar taxes. The Company's prices do not include sales, use, excise, or similar taxes. Consequently, in addition to the prices specified herein, the amount of any present or future sales, use, excise, or other similar tax applicable to the or use of the equipment hereunder shall be paid by the Purchaser, or in lieu thereof, the Purchaser shall provide the Company with a tax exemption certificate acceptable to the taxing authorities. Purchase price will include operation training of Purchaser's personnel when a complete system is purchased. Installation for replacement parts will be charged to the Purchaser on a time, material, and expense basis unless covered under the limited warranty or a service contract.*

SHIPPING: *The Company will use its own judgment in determining the most effective method of shipping unless otherwise specified by the purchaser.*

For additional servicing and information contact:

Fresenius Medical Care (800) 227-2572

Attention: Service Department

4040 Nelson Ave

Concord, CA 94520

The Liberty cyclor is manufactured by :

Fresenius USA, Inc.

4040 Nelson Ave

Concord, CA 94520

Glossary

Abdomen—Area of your body below the chest and above the hips, also called the belly.

Ambulatory—Moving or walking around.

APD—Abbreviation for Automated Peritoneal Dialysis, the use of a machine for peritoneal dialysis.

Aseptic Technique—A series of steps used to keep an area as germ free as possible, including putting on a mask, thoroughly washing and drying your hands, and remembering which parts of your supplies are sterile.

Button—Certain identified sites on the Touch Screen that, when touched, will cause a specific action.

CAPD—Abbreviation for ‘Continuous Ambulatory Peritoneal Dialysis.’ CAPD requires a manual exchange.

CCPD—Abbreviation for ‘Continuous Cycling Peritoneal Dialysis.’ CCPD is a continuous therapy with exchanges occurring throughout the night and sometimes during the day. CCPD requires a cycler.

CCPD Volume—The amount of dialysate delivered during exchanges.

Clean—You have removed most, but not all of the germs. Good hand washing makes your hands clean, not sterile. Your work surface is clean, not sterile.

Cone—Plug at the inside end of a dialysate solution bag. Breaking the cone opens the bag and allows the flow of solution to the connected tubing.

Dextrose (Glucose)—A form of sugar used in dialysate to remove fluid.

Diastolic Pressure—The lower blood pressure number, it describes the blood’s pressure on arteries just before the next heartbeat.

Dialysate—Dialysis solution used to clear waste fluid from your body.

Diurnal—Daytime, opposite of nocturnal.

Drain—Process of emptying your peritoneal cavity of dialysate which carries waste and fluid out of the body.

Drain Time—The amount of time available to drain your peritoneal cavity of used dialysate.

Dry Day—Term for having very little fluid left in your abdomen as a result of no programmed Last Fill for your treatment.

Dwell—Stage of peritoneal dialysis treatment in which the dialysate remains in your peritoneal cavity for a specified amount of time. The dwell time is the time allowed for actual dialysis to take place during each exchange.

Effluent—The used dialysate that your cyclor drains out of you.

ESRD—Abbreviation for ‘End Stage Renal Disease.’

Exchange—Act of replacing the dialysate in your peritoneal cavity. An exchange or cycle consists of three steps: Fill, Dwell, and Drain.

Fibrin—White protein strands that are sometimes found in your drained dialysate.

Flush—Procedure to remove air and potential contaminants from bag line and connections.

Fill—Process of filling your peritoneal cavity with fresh dialysate.

Fill Volume—The prescribed amount of dialysate to fill your

peritoneal cavity during an exchange.

Fill Time—The amount of time available to fill your peritoneal cavity with fresh dialysate.

Increased Intraperitoneal Volume (IIPV)—see *Overfill*

IPD—Abbreviation for ‘Intermittent Peritoneal Dialysis.’ Exchanges usually take place at night with a dry day.

Keys—Located on the Control Panel, keys work outside the Touch Screen to scroll, confirm selections, and stop functions.

Last Bag Fill Volume—This is the volume of dialysate for the last fill. It is in the bag connected to the green clamp line.

Last Fill Volume—The amount of dialysate left in your peritoneal cavity before disconnecting from your machine.

Overfill—Also known as Increased intraperitoneal volume (IIPV) is when you have an amount of fluid in your abdomen that is larger than your prescribed fill volume. Overfill can cause abdominal discomfort, serious injury or death. Some of the symptoms you have if you experience an overfill are:

- Discomfort or pressure in your abdomen or belly
- Shortness of breath
- Chest pain
- Vomiting or spitting up

- Swelling around the genital area, navel, or tunnel tract of the peritoneal dialysis catheter exit site

- Leakage of fluid from your PD catheter exit site

- An unexpected increase in blood pressure

Parameter-Button—A button on the Touch Screen that displays the changeable value it controls.

Pause—An exchange that allows you to Dwell while either connected to or disconnected from your cycler. It differs from other Dwells because it is not a timed function, meaning you may pause for as long as you like.

Pause Volume—The amount of dialysate delivered during the Pause portion of the exchanges.

PD—Abbreviation for ‘Peritoneal Dialysis.’

PD+—Abbreviation for ‘Peritoneal Dialysis Plus,’ a therapy that features pauses prior to nighttime therapy. See *Pause* for more information.

Peritoneal Cavity—Area of your body containing your stomach, liver, intestines, spleen, and pancreas. See also *Abdomen*.

Peritoneal Dialysis—The procedure carried out by your body that pulls the waste products and excess water from your blood stream.

Peritoneum—Smooth semi-permeable membrane which lines the cavity of the abdomen covering internal organs.

Pillow—A clear chamber in the drain line. The pillow lets you check the clarity of your dialysate fluid as it drains. See page 119 for a picture.

Prime—Procedure to remove air from the tubing line that connects to the patient’s catheter.

Screen-button—Any of the buttons located in the Status Bar on the Touch Screen. Touching one of these buttons will display its screen.

SI units—Abbreviation for ‘System, International.’ This is a set of measuring standards that uses the metric system including kilograms (kg), Celsius degrees (°C), and millimole per liter (mmol/L). The Liberty cycler can display values in either SI units or US standard units (lbs., °F, or mg/dL).

Status Bar—Top section of the Touch Screen that shows your machine’s operational mode. It is color coded to show your machine’s status. The Status Bar also alerts the operator to any warning or alarm event.

Sterile—Sterile means completely free of germs. Some of the supplies are packaged to keep them sterile. Some parts of the supplies must remain sterile after opening the package.

Systolic pressure—The higher blood pressure number, it is the blood's pressure on arteries during a heartbeat.

Tidal fill volume—The amount of dialysate to fill your peritoneal cavity during a Tidal therapy exchange. This amount is typically less than CCPD and IPD volumes.

Tidal drain volume—The amount of dialysate that is drained during each Tidal Exchange. Drain 0 and the last Drain of the treatment will drain completely.

TPD—Abbreviation for 'Tidal Peritoneal Dialysis.'

Total sleep time/Total therapy time—The estimated sum of all Drain, Fill, and Dwell time during a treatment.

Total Volume—The total amount of dialysate you need for your treatment.

UF—Abbreviation for 'Ultrafiltration.'

Ultrafiltration—Ultrafiltration is the process of drawing off excess fluid from the bloodstream during treatment.

Urea—Dissolved protein waste product.

USB—Abbreviation for 'Universal Serial Bus.' This is a type of connection used to transfer data. The IQdrive connects to the USB port on the back of your Liberty cyclor.

Index

#
Fills..... 53, 57, 61, 67

A
Add diurnal UF 81
Alarm loudness 83
Alarms 172, 178

B
B (treatment details)..... 137
Bag sensor 39
Birth date..... See Date of birth
Blood glucose 133, 153
Blood pressure 133, 153
Blue line See Lines, Patient
Brightness setting 83
Button Area 25
Buttons
 Description 29
 Details 29, 135
 Hardware 82
 Help 175, 199
 Movement-buttons 29
 My Records 31, 149
 My Settings 31, 47
 My Treatment..... 31, 89
 Options 80
 Parameter-buttons 29
 Patient 70
 Screen-buttons..... 29, 30
 Therapy 48
Bypass 159

C
Cassette
 Catch..... 33
 Description 35
 Door 33
 Guide pins 33
 Inserting 93
 Pump plate 33
 Removal 138, 140
Catheter Line See Lines
CCPD See Continuous Cycling
 Peritoneal Dialysis
CCPD Cycle-Based Settings 52
CCPD Treatment-Based Settings 50
Cleaning 202

Clock 83
Cones 97
Connecting 113, 125
Connector 123, 131, See stay•safe
 connector
Continuous Cycling Peritoneal
 Dialysis 117
Continuous Therapy 21
Control Panel..... 24
Cycle based..... See Therapy

D
Date 83
Date format..... 83
Date of birth, entering 74
Daytime manual exchange 109
Details button See Buttons
Dextrose 133, 153
Diastolic..... 133
Disconnect..... 130
Door latch 33
Door sensor 33
Door, Cassette 33
Drain 117, 118, 194
Drain 0 113, 119, 159
Drain complication 187
Drain line See Lines, Drain
Drain time 53, 57, 61, 67
Dwell..... 117, 126
Dwell time 53, 57, 61, 67

E
Electrical plug 41
Electromagnetic
 Emissions 207
 Environment 207
 Immunity 207
Exchange 117
Extension cap holder See Stay•safe
 system

F
F (treatment details) 137
Fill 117, 120
Fill time 53, 57, 61, 67
Fill volume 53
First Name, entering 70
Flushing 100

G	
Gender, entering	78
Glucose	See Blood glucose
Green line	See Lines, Last

H	
Hardware button	See Buttons
Heater bag placement	94
Heater line	See Lines
Heater tray	38, 41
Help button	See Buttons, See Buttons
Help screens	176

I	
ID, entering	73
IIPV	See Overfill
Intermittent Peritoneal Dialysis	117
Intermittent Therapy	21
IPD	See Intermittent Peritoneal Dialysis
IPD Cycle-Based Settings	56
IPD Treatment-Based Settings..	54
IQdrive	81, 163, 165
Accept settings	165
Handling	143
Inserting	163
Reject settings	165

K	
Key loudness	83
Keys	
OK key	25
STOP key	25
Up/Down Arrow keys	25

L	
Language setting	81
Last bag option	81
Last bag type	133, 153
Last line	See Lines
Liberty Cyclor	
Features	21
Powering up	44
Requirements	12
Servicing	214
Setting up	40
Lines	
Catheter Line	35
Connect	94
Drain	35, 95, 139
Heater	35
Last	35
Patient	35, 113

Solution	35, 95
----------------	--------

M	
Main Area	25
Manual exchange	109
Mask	93, 125
Movement-Buttons	See Buttons
My Records screen-button.	31, 148
My Settings screen-button ...	31, 47
My Treatment Parameters	2
My Treatment screen-button	31, 89

N	
Name, entering	73
New cap holder	See stay•safe system

O	
OK key	See Keys
Options button	See Buttons
Options settings	80
Organizer	See Stay•safe system
Overfill	14, 17, 113, 119, 159

P	
P (treatment details)	137
Parameter-Buttons	See Buttons
Patient button	See Buttons
Patient line	See Lines
Patient line (extended)	107
Patient settings	70
Pause	117
Disconnect	122
Reconnect	124
PD+ Cycle-Based Settings	60
PD+ Treatment-Based Settings .	58
Peritoneal Dialysis	
Contraindications	13
Indications	13
Side Effects	13
Personal Data	152
Personal data option	81
Pillow	35, 119
Pin	35
Power cord	41
Power down cyclor	142
Power failure	196
Pressure sensor	33
Prime	105
Priming	102
Product improvement policy	211
Program mode	49
Pulse	133, 153
Pump heads	32
Pump module	32

Pump plate 33

R

Recovery failure 199

Red line See Lines, Heater

S

S (treatment details) 137

Safety clamp 33

Scale 39

Screen blanking 83

Screen-Buttons See Buttons

SI units 81

Solution bag

 Connect 94

 Detection 99

 Placement 95

Solution line See Lines

STAT drain 157

Status Bar

 Alarm 173

 Description 26

 Warnings 171

Stay•safe

 Cleaning 203

 Connector 35

 System 37

 Extension cap holder 37

 New cap holder 37

 Organizer clip 37

 Tubing channel 37

STOP key See Keys, STOP

Systolic 133

T

Technical Support 15

Temperature 133, 153

Therapy

 Cycle based 49

 Treatment based 49

Therapy button See Buttons

Therapy type 49

Tidal Cycle-Based Settings 66

Tidal Treatment-Based Settings 62

Time

 Format 83

 Setting 83

Touch Screen

 Buttons 28

 Description 25

Treatment based See Therapy

Treatment summary 134

Tubing channel See stay•safe system

Tubing organizer 35

Tubing set

 Description ... See also Cassette

U

Units setting 81

Up/Down Arrow keys See Keys

USB enabled 81

USB enabled option 163

USB Port 163

USB Upload 165

V

Valves 33

Volume (sound) 83

W

Warnings 170, 174

Warranty 211

Weigh heater bag 95

Weight

 After treatment 133, 153

 Entering 76

White line See Lines, Solution

Y

Yellow line See Lines, Drain